

BMZ



Federal Ministry
for Economic Cooperation
and Development



Future-Makers.
Building the future.
Let's join forces.



Micro-gasification: cooking with gas from dry biomass

Published by: **giz** Deutsche Gesellschaft
für Internationale
Zusammenarbeit (GIZ) GmbH



Micro-gasification: cooking with gas from dry biomass

An introduction to concepts and applications
of wood-gas burning technologies for cooking

2nd revised edition



Photo 0.1
Typical flame pattern
in a wood-gas burner,
in this case a simple
tin-can

Contents

Figures & Tables.....	VI
Acknowledgements.....	VIII
Abbreviations.....	X
Executive summary	XIII
1.0 Introduction	1
1.1 Moving away from solid biomass?	2
1.2 Developing <i>cleaner cookstoves</i> for solid biomass?	5
1.3 Solid biomass fuels can be used cleanly in gasifier cookstoves!	6
1.4 Challenges go beyond just stoves and fuels.....	8
2.0 Cooking on wood-gas from dry biomass – how it works	11
2.1 Why switch from the <i>good old camp-fire</i> ?.....	12
2.2 Understanding fire: stages of solid biomass combustion.....	13
2.3 Re-inventing fire: how to control heat and air for clean cooking.....	17
2.4 Small is beautiful, but challenging: making gasifiers suitable for domestic cooking	21
2.5 Nearly as good as gas: performance indicators for gasifier stoves.....	36
2.6 Operation and utilisation of micro-gasifiers in cooking.....	38
2.7 Biomass gasification in a nutshell	44
3.0 Solid biomass feedstock and fuels for micro-gasification	47
3.1 Factors influencing the fuel properties of solid biomass	48
3.1.1 Moisture content has negative effects on fuel economy and emissions.....	49
3.1.2 Particle size impacts fuel performance and gas flow	51
3.1.3 Particle size distribution impacts gas flow	52
3.1.4 Particle shape impacts the convenience of fuel handling.....	52
3.1.5 Fuel density impacts fire-power and burn-time of a fuel-batch	54
3.2 How to get appropriate solid biomass fuels for micro-gasifiers	56
3.2.1 Drying.....	61
3.2.2 Sizing.....	61
3.2.3 Densification.....	68
4.0 Gasifier cookstove diversity	93
4.1 From theory to practice – gaining own experience.....	95
4.2 Catalogue of natural draft stoves for chunky biomass.....	105
4.3 Catalogue of <i>TChar</i> -combinations for chunky biomass	126
4.4 Catalogue of fan-assisted stoves for chunky biomass.....	130
4.5 Catalogue of natural draft stoves for rice husks	133
4.6 Catalogue of fan-assisted stoves for rice husks.....	138
4.7 Devices focused on biochar production in developed countries.....	145
4.8 Further reading.....	146
5.0 Biochar	159
5.1 What is biochar?	151
5.2 Using biochar from gasifier stoves in the field	153
References.....	156

Tables & Figures

<i>Table 2.1</i>	Functional parts of a micro-gasifier and its influence on specific cooking....	35
<i>Table 2.2</i>	SWOT-analysis of micro-gasifier burner units for cookstoves	44
<i>Table 3.1</i>	Unified Bioenergy Terminology	57
<i>Table 3.2</i>	Advantages and disadvantages of using agricultural residues as fuels	57
<i>Table 3.3</i>	Processing needs of different materials	59
<i>Table 3.4</i>	Summary of benefits of densified fuel for use in micro-gasifiers.....	91
<i>Table 4.1</i>	Four do-it-yourself burner concepts described in this manual	97
<i>Table 4.2</i>	Ready-made devices described in this manual.....	97
<i>Figure 1.1</i>	Solid and non-solid fuel use for cooking.....	2
<i>Figure 1.2</i>	Regional distribution of population cooking with solid fuels.....	3
<i>Figure 1.3</i>	Diversified fuel use instead of an energy ladder	4
<i>Figure 1.4</i>	Tiers for emissions of cookstoves operated at high power.....	6
<i>Figure 1.5</i>	Cooking is a multi-dimensional system.....	9
<i>Figure 2.1</i>	Drying and pyrolysis – gas generation is controlled by heat input	14
<i>Figure 2.2</i>	Oxygen-controlled combustion of wood-gas and char gasification.....	15
<i>Figure 2.3</i>	Controlled gas generation separately from gas combustion = gasifier	18
<i>Figure 2.4</i>	TLUD operation compared to the lighting of a match.....	22
<i>Figure 2.5</i>	Basic design features of a char-making TLUD micro-gasifier	23
<i>Figure 2.6</i>	Demystifying TLUD and BBUD operation modes step by step.....	24
<i>Figure 2.7</i>	A stove is a combination of a heat-generator and a heat-transfer structure....	34
<i>Figure 2.8</i>	Emissions of different stoves with low-moisture fuels at high power	36
<i>Figure 2.9</i>	Emissions of different stoves with low-moisture fuels at low power.....	37
<i>Figure 3.1</i>	Moisture reduces the net usable energy for cooking	50
<i>Figure 3.2</i>	Small fuel added on top of vertically stacked wood.....	53
<i>Figure 3.3</i>	Energy per volume of renewable resources compared to fossil oil.....	55
<i>Figure 3.4</i>	Equal power output from different sources.....	56
<i>Figure 3.5</i>	Mechanical energy needed by machinery type to process 1 tonne of material.....	64
<i>Figure 3.6</i>	The Easy-BioGrind by Leland Hite	65
<i>Figure 3.7</i>	Single-shaft shredder	67
<i>Figure 3.8</i>	Guidance tool for identifying appropriate biomass densification options	71
<i>Figure 3.9</i>	Various options for lever presses	73
<i>Figure 3.10</i>	Cylinder for multi-sausage pellet production with a manual lever press...	76
<i>Figure 3.11</i>	Piston for a manual pellet mould	76
<i>Figure 3.12</i>	The principle of a screw-type extruder press	77
<i>Figure 3.13</i>	The principle of a piston press.....	78
<i>Figure 3.14</i>	Construction principle of a flat-die pellet press with rotating rollers	81
<i>Figure 3.15</i>	Principle of a ring-die press.....	85
<i>Figure 3.16</i>	Material flow and power input when pelletising 1,000 kg of straw per hour.....	89
<i>Figure 4.1</i>	Handling of the Malaika	126
<i>Figure 4.2</i>	Drawing of the Mayon Turbo Stove.....	134
<i>Figure 4.3</i>	Airflow with preheated secondary air in the PyroCook.....	145
<i>Figure 5.1</i>	The carbon cycle versus the biochar cycle.....	152



Photo 0.2
Flames from a DKT 3
(see details
in Chapter 4.5.3)

Acknowledgements

This manual was initiated and supported by Dr Marlis Kees, manager of the sector programme *Poverty-oriented Basic Energy Services (HERA)* at the Deutsche Gesellschaft für Internationale Zusammenarbeit (GIZ) GmbH. Without her support and that of the entire HERA-team, the *world's first* resource for micro-gasifiers (1st edition) and its update (2nd edition) would not have been created.

Unless otherwise indicated, all the contents of this manual were written by Christa Roth.

Dr Paul Anderson and Dr Hugh McLaughlin (Professional Engineer, PhD) are the co-authors of *Chapter 2*, having also provided substantial contributions as well as technical review for the other chapters. Kelpie Wilson (Wilson Biochar Associates) and Thayer Thomlinson (Communications Director at the International Biochar Initiative) contributed to *Chapter 5*.

It is gratifying to see increasing interest in this topic since the first edition was released. Micro-gasifiers have been on the agenda of many *Stove Camps* around the world; they have been recognised with awards and included in stove testing rounds yielding encouraging test results.

A word of thanks goes to those who provided reports on activities from the field, including: Stefano Bechis, Felix Chauluka, Johan Eksteen, Gregor Kraft, Bjarne Laustsen, Mattias Ohlson and all the stove producers and stove enablers who contributed data and information.

Thanks go to Matthew Carr, Conor Fox, Elmar Dimpl, Stefan Eichenberger, Daniel Fuchs, Pam Jagger, Dr Agnes Klingshirn, Gregor Kraft, Paul Means, Kevin Mortimer, Crispin Pemberton-Piggott, Dr André Seidel, and Paal Wendelbo for their assistance in reviewing and giving helpful suggestions for improvements on this manual.

Dr Christoph Messinger, Stefanie Röder and Heike Volkmer assisted me with their inputs on structuring the content and making the text more readable.



Christa Roth,
Eschborn, December 2013

Please note:

This manual was made possible by the tax-payers of the Federal Republic of Germany, administered by the Gesellschaft für Internationale Zusammenarbeit GmbH (GIZ). As such, this information is not copy-righted and resides in the public domain. Text passages may be quoted from this manual provided that credit is given to the source. This publication can be downloaded at:

https://energypedia.info/wiki/File:Micro_Gasification_2.0_Cooking_with_gas_from_dry_biomass.pdf

The previous edition is available in English and Spanish at:

https://energypedia.info/wiki/Cooking_with_gas_from_biomass

All links were verified at the time of research for this handbook; please be advised that links might have changed or expired. The authors are not liable for links that are no longer active.

This handbook does not intend to favour any company or specific product. Examples are given that highlight the existence and the source of a particular technology as a reference point. Any links to commercial websites are not-for-profit to the authors and references are by no means exhaustive – this handbook should grow and become more complete over time.

As a *work-in-progress*, this manual hopes to inspire the creation of more experience on the ground that can help spread micro-gasifiers and contribute to exciting new developments. You are most welcome to provide feedback and new information for the next edition to hera@giz.de and/or christa-roth@foodandfuel.info .

Abbreviations

°C	Degrees Celsius
ACS	Advanced cookstove
BBUD	Bottom-burning up-draft
BLEN	Biogas, LPG, electricity and natural gas
BTU	British thermal units
cbm	Cubic metre
CHAB	Combined heat and biochar (applications)
cm	centimetre
CO	Carbon monoxide
CO ₂	Carbon dioxide
DIY	Do-it-yourself
ETHOS	Engineers in Technical and Humanitarian Opportunities of Service
EWB	Engineers Without Borders
FA	Fan-assisted or forced air
FAO	United Nations Food and Agriculture Organisation
FOB	Free-on-board
g	Gram
GACC	Global Alliance for Clean Cookstoves
GIZ	Deutsche Gesellschaft für Internationale Zusammenarbeit (GIZ) GmbH (since January 2011, previously GTZ)
h	Hour
H ₂ O	Water
HERA	GIZ Programme <i>Poverty-oriented Basic Energy Services</i>
ICS	<i>Improved</i> cookstove
ISO	International Standards Organisation
IWA	International Workshop Agreement (reference to a meeting on international cookstove standards in The Hague in February 2012)
kg	Kilogram
kW	Kilowatt
LPG	Liquefied petroleum gas
mg	Milligram
min	Minute
MJ	Megajoule
mm	Millimetres
MPF	Migratory pyrolytic front
ND	Natural draft
O ₂	Oxygen
PCIA	Partnership for Clean Indoor Air
PM	Particulate matter
R&D	Research and development
RPM	Revolutions per minute
SNV	Netherlands Development Organisation
TEG	Thermo electrical generator
TLUD	Top-lit up-draft (gasifier)
USA	United States of America
USEPA	United States Environmental Protection Agency
WBT	Water boiling test
WHO	World Health Organisation

All currencies are indicated with their international codes: EUR, INR, USD, ZAR, etc.



Photo 0.3
Emerging Cooking
Solutions, Zambia

Executive summary

Up to now, efforts to replace solid biomass fuels have largely failed as vast numbers of people still use them. The absolute figures are even set to increase in the next decades being that solid biomass is the most abundant source of vital and renewable cooking energy worldwide.

The most effective way – as measured by cost, health benefits and adaptation rates – to address the current situation is to re-engineer the devices themselves as well as the practices used in converting solid fuel into useable cooking heat. Gasifiers offer just this opportunity: they are devices that produce their own gas from solid biomass in a controlled manner. Gas generation occurs separately from subsequent gas-combustion, and both stages of combustion can be controlled and optimised separately. Gasification is not a new concept but micro-gasification is a relatively new development; it was long a challenge to create gasifiers small enough to fit under a cooking pot. Recent cookstove testing by the USEPA has provided evidence that micro-gasifier cookstoves are currently the cleanest and most efficient options for utilising solid biomass fuels for cooking.

As miniature charcoal kilns, gasifiers can produce charcoal as a by-product of cooking. This stands to revolutionise the way charcoal is produced and utilised in the future. Gasifier cookstoves also have great potential to create downstream value chains through further use of char in agriculture, sanitation, water filtration, etc. Thus they can not only be used in climate change mitigation as a tool for carbon-negative cooking but also play a pivotal role at the increasingly important nexus of water, energy and food security.

The purpose of this manual is to make readers more familiar with gasifier cookstoves as well as improve access and availability for those who need them.



Photo 0.4
A PekoPe char-making gasifier (left) and a TChar stove that can burn char

What can be found in this manual?

The manual reflects the current state of the art in micro gasification for cooking, which is still very much in its infancy but growing up fast. This edition is divided into five chapters:

1. Introduction

Chapter 1 shows that solid biomass fuels will not be replaced in the near future. However, gasifiers currently provide the cleanest option for using these fuels for cooking. Gasifiers make their own gas from dry solid biomass and allow users the ability to *cook with gas*.

2. Cooking on wood gas from dry solid biomass – How it works

Chapter 2 gives insights into how gasification works, why gasifier stoves are proposed as clean cooking solutions and how they can be utilised.

3. Solid biomass feedstock and fuels for micro-gasification

A stove is just as good as the fuel that it is fed. Fuel preparation is crucial for the adoption and performance of micro-gasifier stoves. *Chapter 3* presents various fuel processing options for un-carbonised, processed, low-moisture biomass fuels which are best suited for use in gasifier cookstoves.

4. Gasifier cookstove diversity

Chapter 4 reflects on the worldwide diversity and suitability of gasifier stoves for different fuel types. It has a *observe it on your own* section for people who wish to gain their own experience with micro-gasifiers. A larger section presents a catalogue of various gasifier types and models, their availability and their use throughout the world. Fortunately, the numbers of available micro-gasifiers for cooking have increased considerably since the release of the 1st edition of this manual.

5. Biochar – a by-product of cooking with gasifiers

Due to growing interest in char-producing micro-gasifiers, *Chapter 5*, written by Kelpie Wilson and Thayer Thomlinson, provides insights into the question of *what is biochar?* and presents some examples from the field.

Who should read this manual?

Anybody who can assist in placing gasifiers cookstoves within the reach of people who need them should read this manual, namely:

- a) **Project planners and concept-makers:** Giving them an overview of the numerous technologies and applications of micro-gasification, including the risks, benefits and potential of micro-gasifiers.
- b) **Project implementers and executioners:** Providing entry points to get started testing, adapting and disseminating micro-gasifiers.
- c) **Researchers:** Giving feedback on open challenges and questions that can be addressed in order to advance micro-gasification further.
- d) **Skeptics who fear the risks and doubt the benefits:** Providing them with some food-for-thought and encourage them to enrich further developments.
- e) **Anybody showing interest in the clean use of solid biomass** and those who can foster the adaptation of improved technologies to people's needs across the world.



Introduction

1.0

1.0 Introduction

1.1 Moving away from solid biomass?

Cooking shouldn't kill! is the core message of the Global Alliance for Clean Cookstoves (GACC). It is a widely accepted fact that traditional ways of cooking are associated with increased health risks, particularly for women and children.

Solid fuels – both biomass and fossil fuels – have been considered *the problem*: when used in a traditional manner, high concentrations of harmful emissions can be measured. For many decades, their use was considered a *transitional problem* based on the assumption that societies would eventually move up the energy ladder over time as a result of increased purchasing power and overall economic development.

For many years, the switch from solid fuels to non-solid *cleaner fuels* has been promoted, and with significant success. These include the *BLÉN* fuels (biogas, liquefied petroleum gas (LPG), electricity and natural gas), liquid fuels and solar energy. There has been a consistent increase in the number of people using *modern, non-solid fuels* worldwide, as illustrated in *Figure 1.1*.

Figure 1.1 Solid and non-solid fuel use for cooking

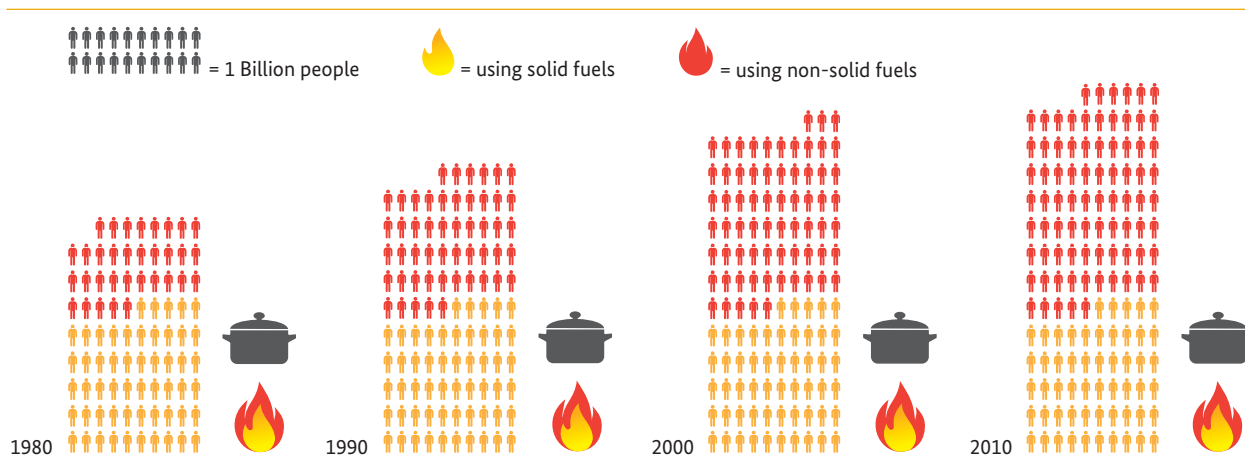

Source: Adapted from WHO and Bonjour et al. (2013)

However, it is also true that over the last forty years the total number of people still using solid fuels for cooking remained fairly constant at around 2.7 billion (see *Figure 1.1*). Distinct regional differences also appear: on the map in *Figure 1.2*, darker shades of red indicate high percentages of solid fuel use, most prevalent in Sub-Saharan Africa. The trends reflected by the stacked bars show that the use of solid fuels for cooking is rising sharply in Africa, while it has nearly disappeared across Europe and the Americas in both relative and absolute terms. However, the bulk of solid cooking fuel usage remains in Southeast Asia, hovering at just over 1 billion people.

Figure 1.2 Regional distribution of population cooking with solid fuels

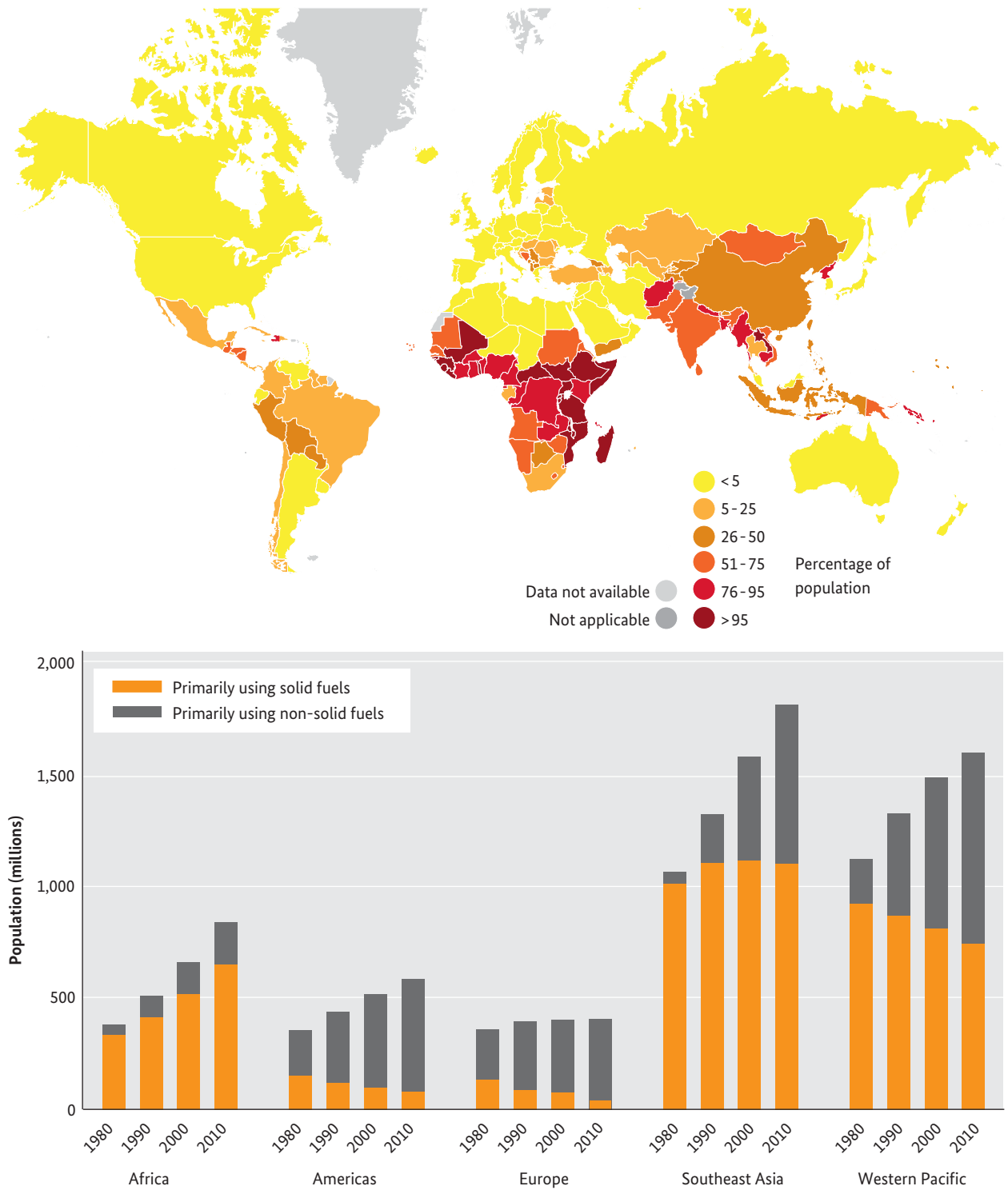

Source: adapted from WHO and Bonjour, et al. (2013)

On the other hand, one can observe that the reason households use *cleaner* fuels is to increase their cooking options as an addition to but not as replacement for solid fuels and traditional stoves. Parallel use of several fuels (referred to as *fuel stacking*) appears to be a common phenomenon, demonstrating that the energy ladder is more of a myth than a reality (see [Figure 1.3](#)).

Figure 1.3 Diversified fuel use instead of an *energy ladder*

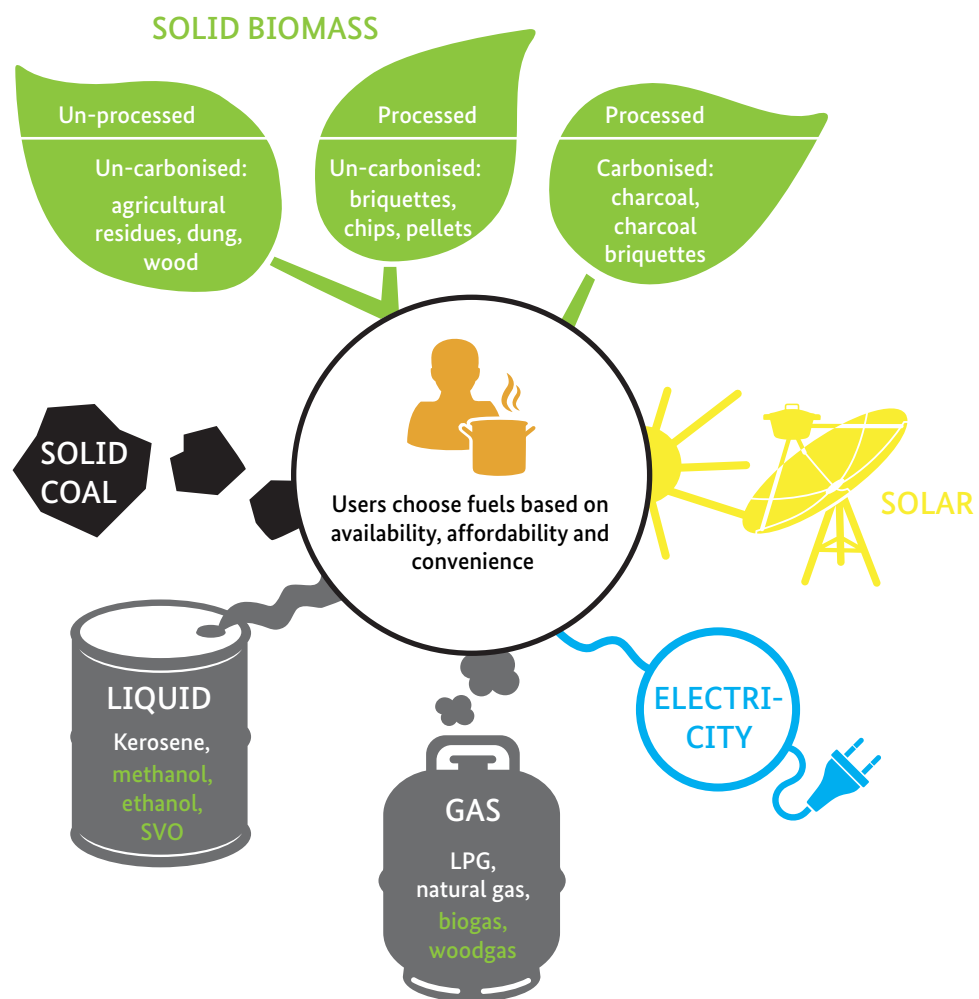

Source: adapted from Roth (2013)

It seems apparent that people do not necessarily progress from one fuel type to the next and completely abandon the type they previously used; instead, users add options to their choices and use several fuels concurrently. Users choose fuels based on the criteria of availability, affordability and convenience. The *energy ladder* therefore takes on the form of an *energy shelf* from which people select the type of cooking energy according to the cooking task, season and other circumstances. For example, barbecue users around the world prefer to use charcoal, regardless of income levels and access to other fuels.

The idea that negative health effects of cooking with solid biomass fuels can be eliminated by simply switching to *cleaner fuels* will not be realised in the near future, if ever.

1.2 Developing *cleaner cookstoves for solid biomass?*

In the past 40 years, improved cookstoves (ICS) have been developed with the goal of increasing fuel efficiency. The adverse health impacts of cookstoves had tended to be overlooked until recently. New efforts now focus on further improving existing ICS in burning solid biomass fuels efficiently as well as making them cleaner. These *advanced cookstoves* (ACS) are often industrial products made of high quality materials. The introduction of systematic emissions testing (using WHO-recommended indicators) has shown both the potential and the limitations of ACS: according to the tiered rating system for cookstove performance proposed by the ISO International Workshop Agreement (IWA) in 2012, ACS show potential for substantial improvements compared to 3-stone fires (the lower end of tier 1), but fail to reach tier 4, which entails targets established using the very low emissions of stoves operated with gas or liquid fuels. Re-engineering the devices and practices that convert solid fuels into useable cooking heat is needed to address the current situation.

Figure 1.4 shows the proposed IWA tiers for the major health-relevant emissions of carbon monoxide (CO) and fine particulate matter (PM 2.5) for stoves operated at high power. Most ACS still fall into Tier 2 while well-performing *gasifier cookstoves* that use fans come closest to the aspirational targets for tier 4, e.g. the Philips HD4012 or the Teri SPT_0610 designs. (see details in *Chapter 4.4*)

Figure 1.4 Tiers for emissions of cookstoves operated at high power

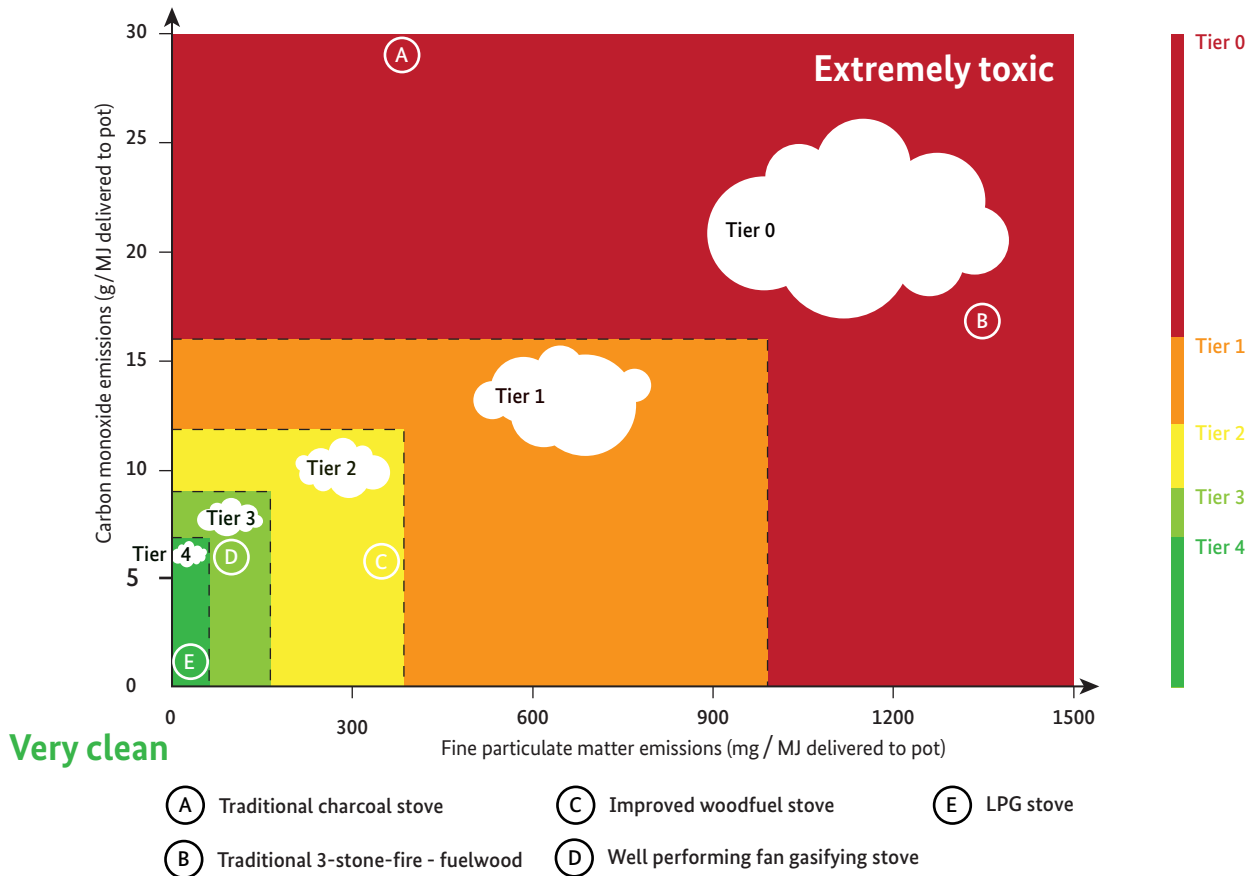

Source: adapted from Jetter (2012)

1.3 Solid biomass fuels can be used cleanly in gasifier cookstoves!

The variety, *unpredictability* and inconsistency of natural solid biomass are the primary challenges for clean combustion in a cookstove. However, this by no means makes biomass a *dirty fuel*; if solid biomass is converted into a predictable fuel such as woodchips, briquettes or pellets and burned in a gasifier cookstove, emissions have been proven to come closest to the aspirational targets of IWA tier 4. Micro-gasifiers are nearly *as clean as cooking with gas* (see the location of the icon for the fan assisted gasifier stove in *Figure 1.4*).

Why? Because gasifier stoves are cooking with gas. Gasifier stoves are gas-burners that produce their own gases from dry solid biomass.

The evidence clearly indicates that solid biomass is not the problem per se; rather, the problem lies in the way biomass is commonly used.

The development of micro-gasification is relatively new in the cooking energy sector. It is still at an early stage of development and many stakeholders are not yet aware of the potentials and challenges of revolutionising the way we make fire to cook food. A gasifier cookstove powered by *wood-gas* from dry solid biomass shows great promise for making an important contribution to the goal of reducing the negative health-effects of household air pollution from cooking.

Gasifier or *wood-gas* stoves have certain advantages ...

... compared to other improved cookstoves (ICS) operated with solid biomass:

- cleaner burning of solid biomass (considerable reduction of soot, black carbon and indoor / outdoor air pollution)
- fuel efficient due to more complete combustion (less total biomass consumption)
- use a variety of small-sized biomass residues (no need for stick-wood or charcoal)
- easy lighting allows for cooking to commence within minutes, much faster relative to lighting charcoal.

... compared to stoves operated on alternative fuels (liquid, *BLEN* or solar):

- solid biomass fuels are often available locally (affordable access and user convenience), easy to transport and easy to store once gathered
- creation of wood gas from dry solid biomass can be achieved with very simple and inexpensive technology directly within the burner unit, which is portable and does not require piping or special burner-heads (in most cases)
- unlike cooking with biogas, wood gas is independent from a bio-digester and a regular supply of water since the wood gas stoves make their own gas
- approaches the convenience of fossil gases
- *gas* is available on demand, unlike electricity or LPG that are dependent on local providers and imports, and unlike solar energy that is dependent on clear weather and daylight hours.

Another benefit, as perceived by some, is the ability of gasifiers to produce and deliver charcoal. These pyrolytic gasifier stoves can convert dry solid biomass into charcoal, acting as miniature charcoal kilns. This char can be used as charcoal for cooking, sold, further processed into charcoal briquettes, or turned into *biochar* for use as a soil amendment that aids in improved water retention capacity and plant nutrient availability of depleted soils – topics of great importance and much current research.

Users might, however, encounter some unresolved challenges associated with this relatively new micro-gasification technology:

- Micro-gasifiers require small-sized fuel inputs: firewood in the form of large logs or sticks is more suited to other types of improved stoves.
- Most micro-gasifiers are batch-loaded and are not intended to be refuelled during use. As a consequence, cooking times are pre-determined by the size of the fuel container.
- The heat output of most micro-gasifiers is not easy to regulate unless the stove is operated with a fan for forced convection, in which case the power of the fan can be regulated.

1.4 Challenges go beyond just stoves and fuels

Improvements to well-engineered stoves and fuels have proven to enhance the performance of cooking energy devices when tested in the laboratory. However, we should not assume that this directly translates to actual improvements within households; the entire cooking system is much more complex. Users not only make choices on *stoves and fuels*, they also decide on which meal to make, which cooking equipment (pots and pans) to use and, most importantly, how to cook (cooking practices ranging from high-heat stir-fries to low-heat simmering). The decision on where to cook (cooking environment, ventilation context) determines the concentration and dose of harmful cookstove emissions to which people are exposed. Cooking outdoors, in a well-ventilated space or with a chimney reduces the negative health impacts: one *solution to pollution is dilution*.

Studies have shown that improved ventilation is one of the most easily adopted and cost-effective approaches to lowering the health impacts of current cooking applications. Disseminated concepts such as *don't breathe the smoke - it is bad for you* can lead to significant benefits. Unfortunately, the tangible health consequences and the cumulative impact of breathing smoke are often delayed. It is therefore preferable to promote the use of stoves without smoke than to expect impoverished people to avoid smoky kitchens altogether.

In short, user behaviour directly influences *performance* within the multi-dimensional cooking energy system (see [Figure 1.5](#)).

Figure 1.5 Cooking is a multi-dimensional system



Source: adapted from Messinger (2011)

If we really want to assure the positive environmental and health benefits of improved cooking energy services, we have to go far beyond stoves and fuels. The most important factor for the overall achievements *is in front of the stove*, namely the cook. User behaviour is crucial in turning the theoretical and emerging potentials of gasifier stoves into practical realities.



**Cooking on wood-gas
from dry biomass – how it works**

2.0

2.0 Cooking on wood-gas from dry biomass – how it works

Biomass can be thought of as solar energy stored in the form of chemical energy. Plants use the energy from sunlight to photosynthesise solid biomass from elements without initial combustible value: carbon dioxide (CO₂) from the atmosphere and water (H₂O) from the soil. Thus, biomass consists of long-chain organic polymers, mainly sugars like cellulose, composed of carbon (C), hydrogen (H) and oxygen (O). In addition, there are minerals (the inorganic fraction also called *ash*) that are left over once the organics have been *burned*. Burning can be conceived as the opposite of photosynthesis in that oxygen from the air and the organic portion of the biomass react to convert chemical energy stored in the biomass into thermal energy – heat and light (see *Figure 5.1 on the carbon cycle in Chapter 5*).

2.1 Why switch from the good old camp-fire?

The ancestors of mankind mastered the art of *fire-on-demand* and improved their nutrition by cooking foods. To this day, we release energy stored in biomass through combustion and utilise the generated heat for cooking and other applications. Though solid biomass is the oldest of cooking fuels, billions of people still rely on it daily for their cooking needs. Biomass serves as an ideal renewable energy carrier for creating thermal energy on demand.

The challenges associated with this energy carrier include managing its sources sustainably and using the resource more efficiently and with less harmful emissions compared to the *good old open campfire*.

Did you know that wood does not burn? But wood-gas does!

Indeed, solid biomass cannot burn directly. It first needs to be transformed into a gas, which can then be combusted when mixed with a certain amount of oxygen and ignited.

There are growing environmental concerns about deforestation and forest degradation which have been aggravated by a level of demand for biomass energy that far outstrips sustainable supply.

As of late, there has also been growing concern about the negative health effects of smoke from open fires and rudimentary cookstoves operated with solid biomass or coal. Conventional improved combustion stoves are not yet advanced enough to foster noticeable positive health effects. There is an ardent quest to shift to cleaner fuels such as LPG or electricity for the sake of health. However, for billions of poorer households, this will not be a realistic scenario for years to come. We have to accept the fact that solid biomass will be the cooking fuel of choice for many of these households for the future decades. On account of their clean and efficient *combustion* of biomass, gasifiers do have the potential to bridge this gap and offer users the convenience of cooking with gas derived from the solid biomass fuels they are familiar with.

2.2 Understanding fire: stages of solid biomass combustion

Only once we understand how biomass combustion works can we apply some principles to optimise its use. There are four stages described in the process of biomass combustion: 1) drying, 2) pyrolysis, 3) combustion and 4) char gasification.

Did you know that one must first put in a certain amount of heat before one can gain useful heat from solid biomass?

Energy derived from biomass is set free through the oxidisation of carbon and hydrogen, which cannot happen when they are still bound in long-chain organic polymers like cellulose, hemicellulose or lignin. The complex structures of the plant need to first be broken up and converted into smaller molecules that vaporise and react with oxygen in the air. Energy is first needed to break these bonds and evaporate the wood-gas. This is done with thermal energy. In other words, we need to add some heat first!

2.2.1 Both drying and pyrolysis require the input of heat

A temperature of over 300° C is required to start the pyrolysis process and create combustible *wood-gas*. In most cases, this *external* heat is initially provided by a lighting material such as kerosene or a match. Once the temperature begins to increase the following processes occur:

1) DRYING: As the biomass heats up and approaches 100° C, excess moisture contained in the biomass changes from liquid into water vapour. Excess moisture evaporates into the atmosphere and leaves a solid dry biomass behind.

2) PYROLYSIS: At temperatures beyond 300° C, biomass starts to pyrolyse (translation: *break apart by fire*). Increased temperatures eventually cause a complete conversion of the biomass into volatile vapours and a solid residue called char. The vapours contain various carbon compounds with fuel value, referred to as *wood-gas*. Being that the solid by-product of this process is char, mostly composed of pure carbon, the process is also termed *carbonisation*.

Pyrolysis and carbonisation are like opposite sides of the same coin, depending on if one focuses on the generation of wood-gas or the creation of char.

Drying and pyrolysis are both endothermic processes, which means that they consume heat and do not create any useful surplus of heat.

The speed of the process is determined by the amount of available heat input and how much heat is required to first dry out the fuel before the temperature of the biomass can attain a level at which pyrolysis can start: using air-dried fuel (moisture content of 10% – 20%) is recommended in order to shorten the drying time and reduce the required heat input.

Figure 2.1 illustrates the process of drying and pyrolysis / carbonisation with a simplified example of 1,000 g of wood with a moisture content of 20%. In each step, vapours are released and the remaining solids decrease in mass and volume. The 1,000 g of wood turn into 800 g of dry wood, while the equivalent of a 200ml glass of water is evaporated (freshly cut wood can contain as much as 50% moisture or more!).

With temperatures approaching 600° C, the pyrolysis process converts the 800 g of dry wood into combustible wood-gas and 200 g of solid char.

Figure 2.1 Drying and pyrolysis – gas generation is controlled by heat input

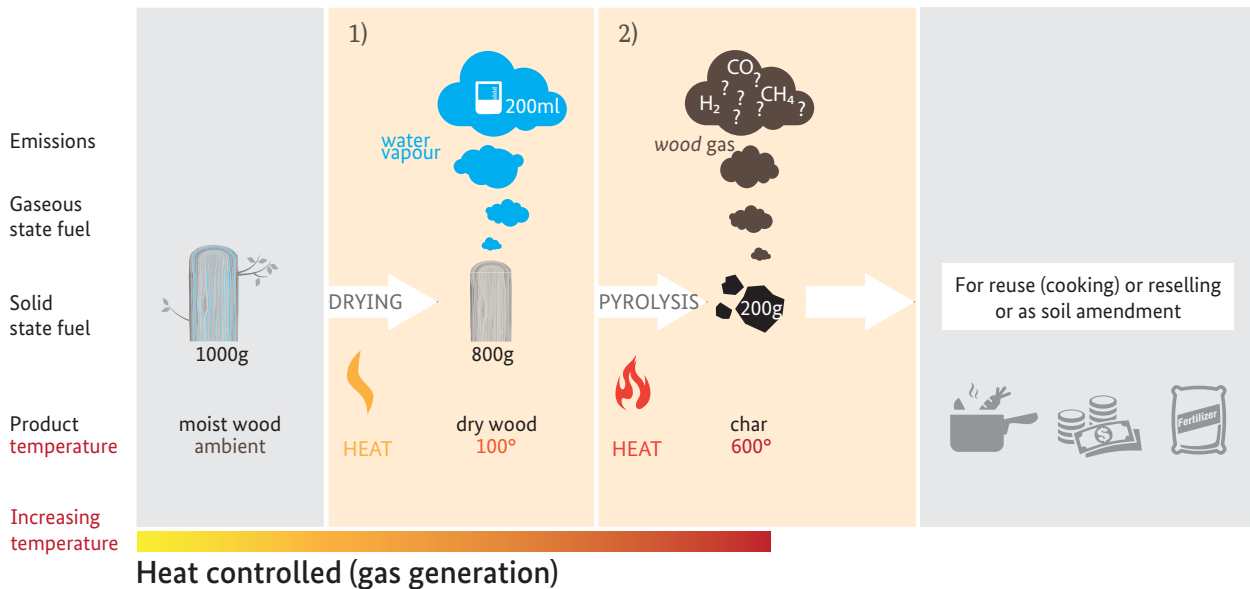

Both the vapours and the solid char are now excellent fuels that can be combusted with oxygen to generate heat.

The char can further be used to continue cooking while it is still hot. It can also be cooled and then sold as a fuel or incorporated into the soil as biochar, thus sequestering carbon from the atmosphere.

Remember: Drying and pyrolysis are controlled by heat input; they do not require oxygen.
In short: No heat input, no pyrolysis, no wood-gas for burning and no fire.

2.2.2 Wood-gas combustion and char gasification require oxygen from the air

Oxygen is required for the next two steps of the process, namely wood-gas combustion and char gasification. Both transformative processes are exothermic oxidation reactions. Surplus heat is released that can be utilised (e.g. for cooking). Oxygen for this process is usually taken from the air.

3) WOOD-GAS COMBUSTION takes place when all fuel is in a gaseous state. The wood-gas created by pyrolysis in the previous stage attains the form of energy-rich

Figure 2.2 Oxygen-controlled combustion of wood-gas and char gasification

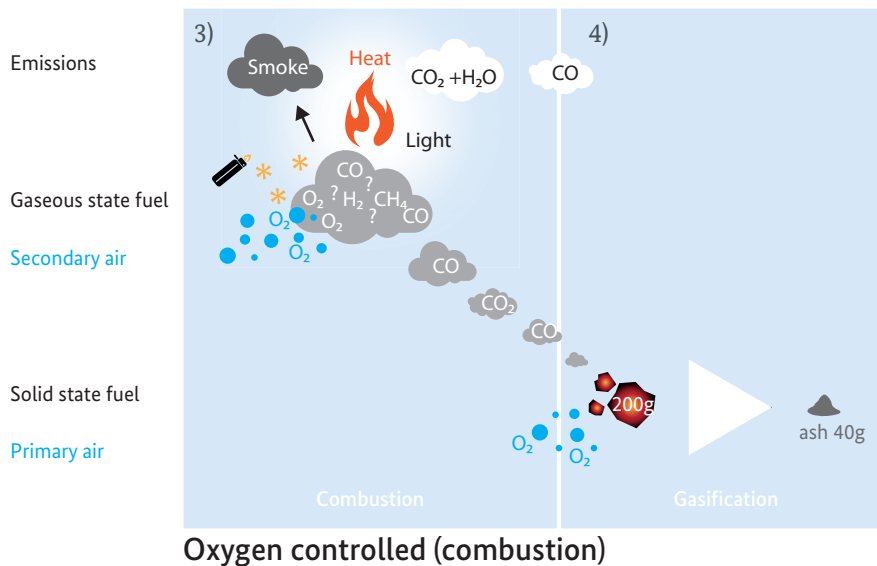

vapours and gases. These are now ready to react with oxygen. This step requires for oxygen provided via secondary air to be thoroughly mixed with the freshly generated hot wood-gas, which is then ignited by a spark or by heat from an existing flame, as shown in [Figure 2.2](#). This process is called combustion, leading to the creation of carbon dioxide, water vapour, heat and light – a flame is the visible evidence of combustion. Ideally, only fully oxidised gases without unreleased energetic value escape the combustion zone – meaning that all wood-gas has been oxidised into carbon dioxide and water vapour. This is the reverse process of photosynthesis.

Please note: Air that reaches the solid fuel-bed in the reactor is called **primary air**. Air added to gases in the combustion zone above the fuel-bed is called **secondary air**.

4) CHAR GASIFICATION takes place in the solid fuel phase. It is the step during which solid char created by pyrolysis is converted to ash. It is independent of the combustion process and only takes place when additional oxygen reaches the red hot char while it is still hot enough to react (above 500° C). At this point, *char gasification* occurs: oxygen reacts with the solid char in the fuel bed, creating carbon monoxide which adds to the *wood-gas* cloud of combustible gases. The oxidation process releases heat into the fuel bed. As temperatures increase, the glowing embers of the char turn from red to bright orange. By the end of the process, only non-burnable solid minerals remain behind in the form of ash (see the right side of [Figure 2.2](#)).

Char gasification can be halted by inhibiting the flow of primary air oxygen.

The three T's of combustion: Time – Temperature – Turbulence

Complete and efficient combustion can be enhanced by

- 1) Lengthening the time that the reactants (air / oxygen and fuels) remain in contact;
- 2) Raising the temperature of the reactants (air and fuel) or that of their contact environment
- 3) Increasing turbulence to promote the thorough mixing of air and fuel.

When the combustion process remains incomplete, undesirable emissions are created; this is either due to a lack of oxygen in the combustion zone or to the vapours cooling down below the point at which they burn. Wood-gas can escape in the form of visible, often irritating, smoke. Char-gas remains in the form of carbon monoxide, an odourless, imperceptible, and toxic gas – carbon monoxide is poisonous and a danger to human health.

Remember: Combustion and char gasification are controlled by the available amount of oxygen. In short:

No oxygen, no gas generation from the hot char; instead, char is conserved.

No oxygen, no complete combustion; vapours and gases escape as *smoke*.

2.2.3 The open fire – an uncontrolled combustion process

Heat is *consumed* during the drying and pyrolysis process. This is why matches or some other lighting source is used to start a fire. Once lit, the heat radiated by the flames and / or hot char provides the source of high temperature necessary to stabilise the oxidation reactions that release heat and continue fuel pyrolysis. More gases are then generated, combusting in yellow and blue flames above the *burning* wood fire.

In an open fire, shown in [Photo 2.1](#), all four stages of the *burning* process occur simultaneously in a rather uncontrolled manner:

- raw fuel at the left side of the photo
- yellow flames at the centre, indicating wood-gas combustion
- red-glowing embers, indicating char-gasification at high temperatures and
- charred black wood partially covered by grey-white ash (right).

The stick lying across the fire (indicated by the arrow in *Photo 2.1*) visualises the progression of pyrolysis: the right end is already covered with ash, indicating char gasification at high temperatures. The embers radiate heat towards the unburnt colder zones causing pyrolysis to progress towards the raw left end of the stick; this creates a black charred transition zone as it moves on.

To the left, we see the unburnt colder end with visible smoke but no flames, as temperatures are not yet high enough to auto-ignite the white pyrolytic vapours and gases, which escape as smoke mixed with water vapour from the drying process. Neither the temperatures nor the input of air are controlled in this scenario. Some areas are exposed to excessive cold air, cooling the fire, whilst embers accumulate in areas where there is not enough air. This fire releases high emissions and therefore does not provide *clean* heat for cooking purposes. It also uses much more fuel than otherwise necessary since it inefficiently converts biomass into useable heat.



Photo 2.1
Uncontrolled
camp-fire

2.3 Re-inventing fire: how to control heat and air for clean cooking

The purpose of burning biomass for cooking is the heating of food. For as long as a fire sustains itself and produces excess heat, this heat can be used for cooking. In order to protect the cook and those around him/her from exposure to harmful smoke, combustion should be optimised so that it is as complete and clean as possible.

2.3.1 The gasifier principle: separating gas generation from gas combustion for improved control

The idea behind a *gasifier* is the separation of the stages of combustion according to their main drivers: HEAT for gas-generation, drying, and pyrolysis; and AIR for gas combustion. Gasifiers allow for the optimisation of the conditions for each step in the conversion process:

- regulating HEAT reaching the solid biomass for optimising the drying and pyrolysis process
- controlling the supply of AIR and regulating the availability of oxygen for optimising the subsequent steps of wood gas combustion and char gasification.

By controlling and optimising the inputs of heat and air, exceptionally clean combustion of solid biomass can be achieved.

The gas generation stage happens first, followed by a gas combustion stage which can take place even at a separate location.

Figure 2.3 Controlled gas generation separately from gas combustion = *gasifier*

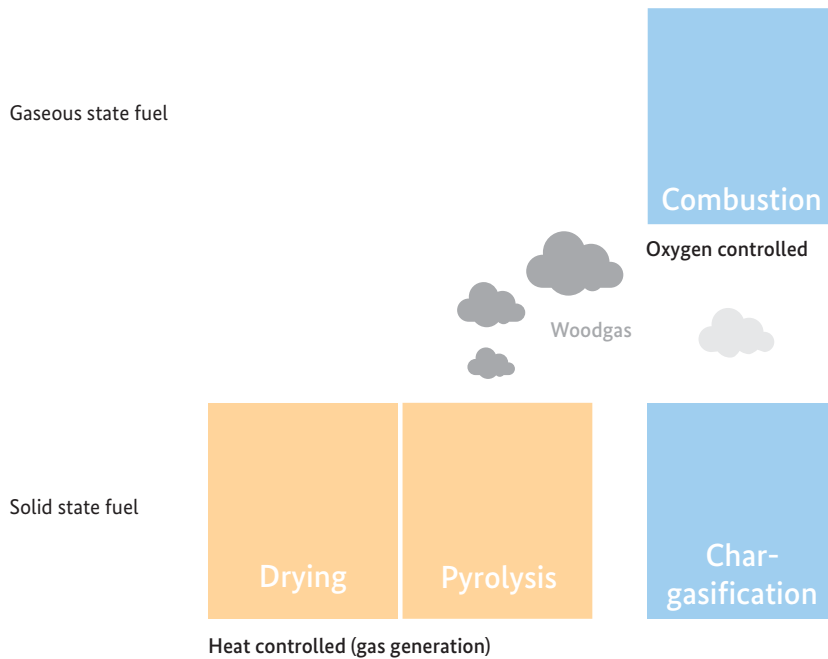

2.3.2 Biomass gasifier characteristics

A **biomass gasifier** is the general term for a device that can separate the stages of combustion. Unlike with an open fire, the gas-generation is controllably separate in space and time from the subsequent gas-combustion.

In a **reactor (gas generator)** that is optimised for **heat-dependent drying and pyrolysis**, solid biomass is first converted into gases and vapours. These are guided into a **combustion zone (gas burner)** where **oxygen from the secondary air** is mixed in to burn the generated gases in a controlled manner. Though the heat output of open fires and most conventional cookstoves is regulated by the fuel supply, most gasifiers are **controlled by the air supply**. One major challenge is getting the right amount of air to the right place at the right temperature.

Primary air control can allow for the suppression of char-gasification so that the char can be conserved. The ability of char-making gasifiers to produce charcoal (*biochar*) as a by-product of the cooking process is gaining increased interest, as the debate on climate change has sparked a search for global carbon-negative bio-energy systems. If the created char is not converted into carbon dioxide for further heat production, but rather saved and used as a soil supplement, it can sequester the carbon from the atmosphere. Read more on biochar in [Chapter 5](#).

For the purposes of cooking, it is most useful to have the combustion zone close above the gas-generation zone and burn the gases while they are still hot.

As a side note: This manual concentrates on the application of small-scale micro-gasifiers for cooking purposes and not on electricity generation or powering vehicles. These applications are described in other publications (e.g. GIZ 2011).

2.3.3 Ways to maintain gas generation in a gasifier

A significant difference among gasifiers is the source of heat for the pyrolysis process in the reactor, the **engine of pyrolysis**.

- Allothermal or indirect gasifiers use an external heat source: heat generated from another fuel outside of the reactor is used to pyrolyse the fuel inside the reactor. Air-dependent combustion processes only happen outside of the actual fuel reactor. This is used, for example, in retort kilns to produce charcoal.
- Authothermal or direct gasifiers produce their own heat through the partial combustion of gases within a fuel-bed in the reactor. Therefore, a restricted supply of primary air is needed, just enough to burn a small fraction of the gases and generate sufficient heat for pyrolysing additional fuel and creating more gas. Small flames and glowing char form within the fuel-bed. As air supply is limited the gases do not fully combust. Combustion is later completed inside of the designated combustion zone above the fuel-bed when secondary air is added.

Most stoves described in this manual rely on the latter system and create their own heat from the partial combustion of gases in a migratory pyrolytic front (MPF), functioning as a self-sustaining heat source. The details of this process are described in the following paragraphs.

2.3.4 Not all biomass gasifiers are created equal

There are various parameter options and design features for gasifiers:

- location of the combusting gas-burner (closely coupled with or separated from gas generation as a remote burner)
- flow direction of the gas (up-draft / counter-flow, down-draft/co-flow, cross-draft, etc.)
- gas pressure during operation (atmospheric, suction and pressurised)
- gasifying agent (natural air, pure oxygen)
- method for creating draft and flow speed for the gasifying agent (natural draft, fan assisted, draft-induced – e.g. with a chimney)
- method of gas / fuel contact (fixed bed, fluidised bed, entrained flow, etc.)
- feedstock (chunky, granular pieces, or fine material like sawdust or ricehusk)
- ash form (dry ash, slagging or melting ash at higher temperatures forming clinker)
- scale of the operation and the size of the device (micro, small, medium, large industrial application systems)
- gas cooling and cleaning process (relevant for major industrial processes in which gases are transported and / or stored before subsequent use)
- immediate purposes (heat or electricity generation through product gas, waste management, etc.).

Remember: Gasification occurs in stages. Pyrolysis converts wood into char and gases. It is controlled by heat input and can be slowed by cooling. Char gasification converts char into ash and gases. It is controlled by oxygen and can be arrested by the deprivation of oxygen. Wood-gas refers to the gases and vapours produced by pyrolysis and char gasification. Combustion occurs when wood-gas is mixed with oxygen and ignited. Unlike open fires, all the stages of gasification and combustion can be controlled in a *gasifier* so that they deliberately occur distinctly separated in time and location.

2.4 Small is beautiful, but challenging: Making gasifiers suitable for domestic cooking

The fundamental challenge in gasifier development has been to make them small enough to fit under a cooking pot in individual households.

Since pyrolysis requires high temperatures and sufficient heat transfer into cold biomass, creating small *micro-gasifiers* has been difficult. The following design features and principles can be adapted in consideration of economic and practical / applicability issues:

- **ambient air** as the gasifying agent (available at no cost)
- operation at **atmospheric pressure** (no pressurised storage of fuel or air needed)
- **fixed fuel-bed** (fuel does not need to be moved during operation)
- creation of independent **heat for pyrolysis** through partial combustion of gases with primary air: an autothermal *engine* to keep a migratory pyrolytic front (MPF) progressing through the fixed fuel-bed
- **close-coupled combustion** of the produced gases: they are combusted directly above the gas generating zone and the fuel-bed while still hot. The heat can directly reach a cooking pot. No cooling, scrubbing or piping of the gases needed
- **top-lit**: Most micro-gasifiers for cooking purposes are lit at the top of the fuel-bed. This is an easy way to keep the heat directly under the cooking pot. Many micro-gasifiers work with batch-loaded fuel, meaning the fuel container is filled only once and then lit at the top
- **up-draft**: The air and the combustible gases flow upwards, while the MPF moves down-wards. Up-draft designs are easy options for cooking purposes since hot gases naturally rise since they are lighter than cold ambient air. This creates a natural draft through the fuel-bed, facilitating the oxygen supply to the MPF for partial combustion of the gases. Depending on the fuel type and the density of the fuel-bed, fans can be added to force air through the fuel-bed for a suitable flow of oxygen.

Many attempts have been made to classify gasifier stoves. There is, however, one caveat: some terms tend to describe the *operation principles*, referring to the manner of using a device and not necessarily to the structural principles of a device. For gasifiers, everything depends on how the air and fuel supply are controlled. Some devices allow the user to switch among operation modes. The following chapters describe the top-lit up-draft (TLUD) and the bottom-burning up-draft (BBUD) operation modes.

2.4.1 One common example – Top-Lit Up-Draft (TLUD) gasifiers

A good way to demonstrate the TLUD operation is to light a match, like the one depicted in part A of *Figure 2.4*. Everybody has witnessed such a flame progress down the matchstick from the head towards the fingers. A yellow flame forms above the match and char is left behind. If we hold the match vertically with the head pointing upwards, like in part B, the match becomes a top-lit device. The air moves upward with draft created by the heat of the flame. Primary air reaches the solid wood below the flame, and secondary air mixes with the flame (the combustion zone) above.

Figure 2.4 TLUD operation compared to the lighting of a match

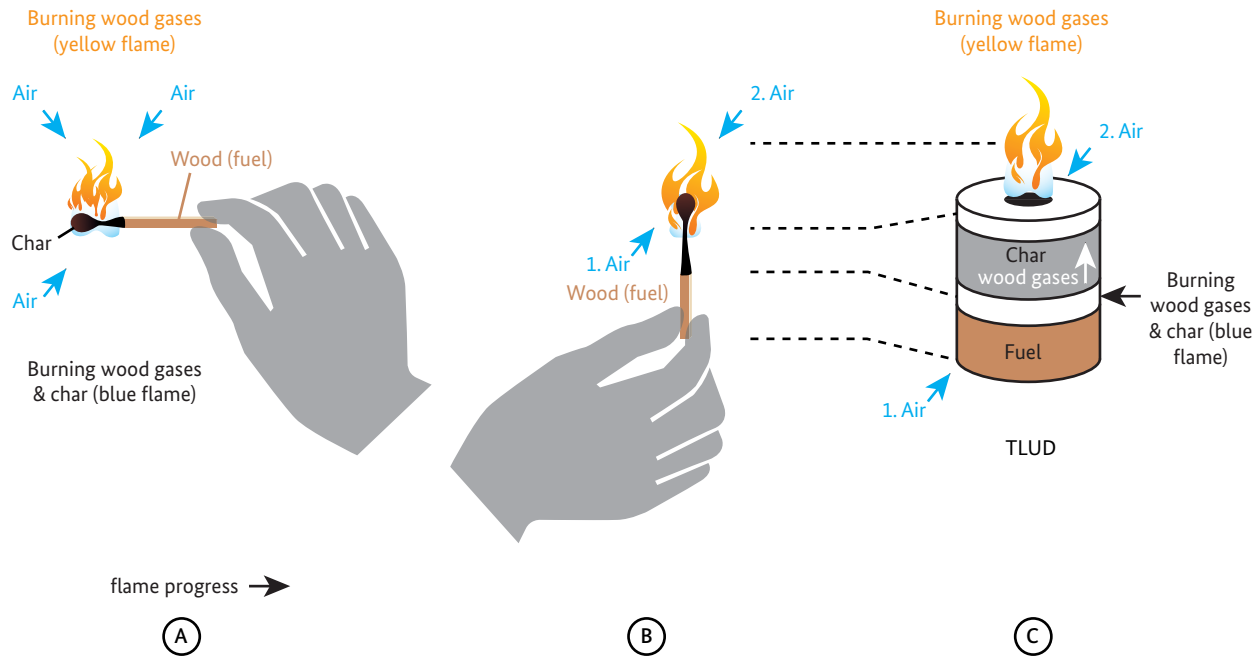

Source: author's illustration based on an idea by Hugh McLaughlin

As shown in part C, a TLUD gasifier functions very much the same way, only that the fuel is not a single match-stick but any type of dry biomass filled in a container.

The stack of fuel is lit at the top; the visible flame is in the combustion zone where secondary air is added above the fuel. The major difference is that there is an additional zone within the fuel container where a small amount of the wood-gas is combusted with limited primary air: this is referred to as the migrating pyrolytic front (MPF). It creates self-sustaining heat for the pyrolysis process and migrates downward through the fuel bed, leaving char behind.

The main design features of a TLUD allow for air-control and respect the *three T's* of *clean combustion* (see [Figure 2.5](#)):

- **Reactor:** Holds a batch of fuel loaded from the top.
- **Air control:** Restricted primary air entering the reactor at the bottom with secondary air entering the combustion zone above the fuel bed; the recommended ratio is 1 part primary air to 5 parts secondary air.
- **A double wall** that minimises heat losses and also pre-heats secondary air can increase the temperature to enhance pyrolysis during gas-generation and oxidation reactions during gas-combustion (*temperature*).
- **A riser** above the combustion zone can increase draft, as well as space and residence time of the hot gases in order to complete combustion (*time*).

- A **concentrator disk or forced secondary air** assists in the thorough mixing of the hot gaseous fuel with oxygen provided by secondary air to ensure optimal combustion (*turbulence*). Using the radius of the fuel container as the diameter of the hole in the concentrator disk usually works well.

Figure 2.5 Basic design features of a char-making TLUD micro-gasifier

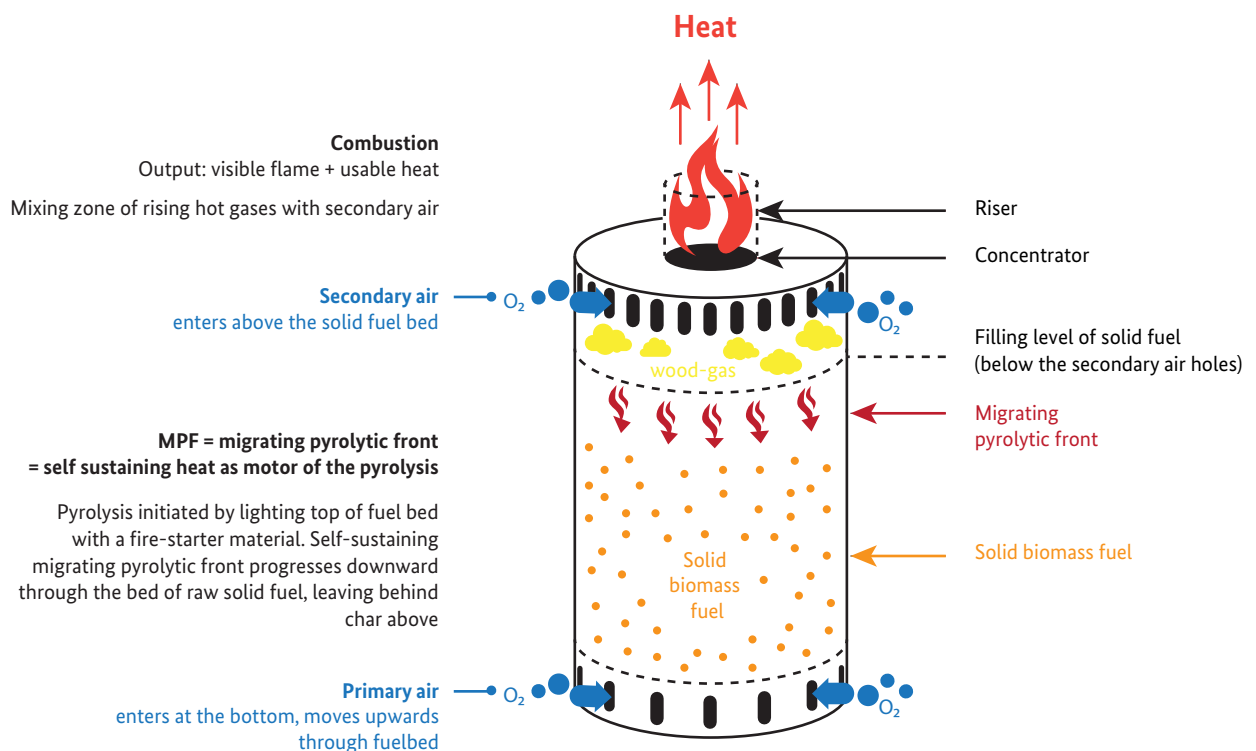

In TLUD gasifiers, fuel does not get moved, the only movement being a decrease in volume during pyrolysis. Two other things do move:

- A hot *migratory pyrolytic front* moves downward through the mass of solid raw fuel, converting the biomass into char. This is also referred to as a *flaming pyrolysis front*.
- The gases created travel upwards towards the combustion zone while char remains behind above the pyrolysis front.

The first known micro-gasifiers by Tom Reed and Paal Wendelbo were char-making TLUDs with a migratory pyrolytic front (MPF) and a restricted supply of primary air. Char gasification can be suppressed and the char conserved if no primary air reaches the hot char at the end of the pyrolysis phase. This is the reason that TLUDs are also called *pyrolytic stoves*.

Serving as a miniature charcoal kiln, gasifiers can produce charcoal as a by-product of cooking. This may revolutionise the way charcoal is produced and utilised in the future. Gasifiers also have great potential to create downstream value chains through further use of char in agriculture, sanitation, water filtration, etc. If char is conserved, cooking with biomass can be a carbon-negative activity and sequester carbon from the atmosphere as a tool for climate change mitigation.

Gasifier cookstoves may play a pivotal role at the nexus of water, energy and food security.

TLUDs are easy to adapt and replicate within individual projects without patent infringement or copyright issues. The simplest TLUD can be in the form of a single tin-can combustion unit with separate entry holes for primary and secondary air, as shown in the *Photo 0.1* on page IV.

The following paragraphs describe what occurs inside of a TLUD-gasifier step by step:

Figure 2.6 Demystifying TLUD and BBUD operation modes step by step

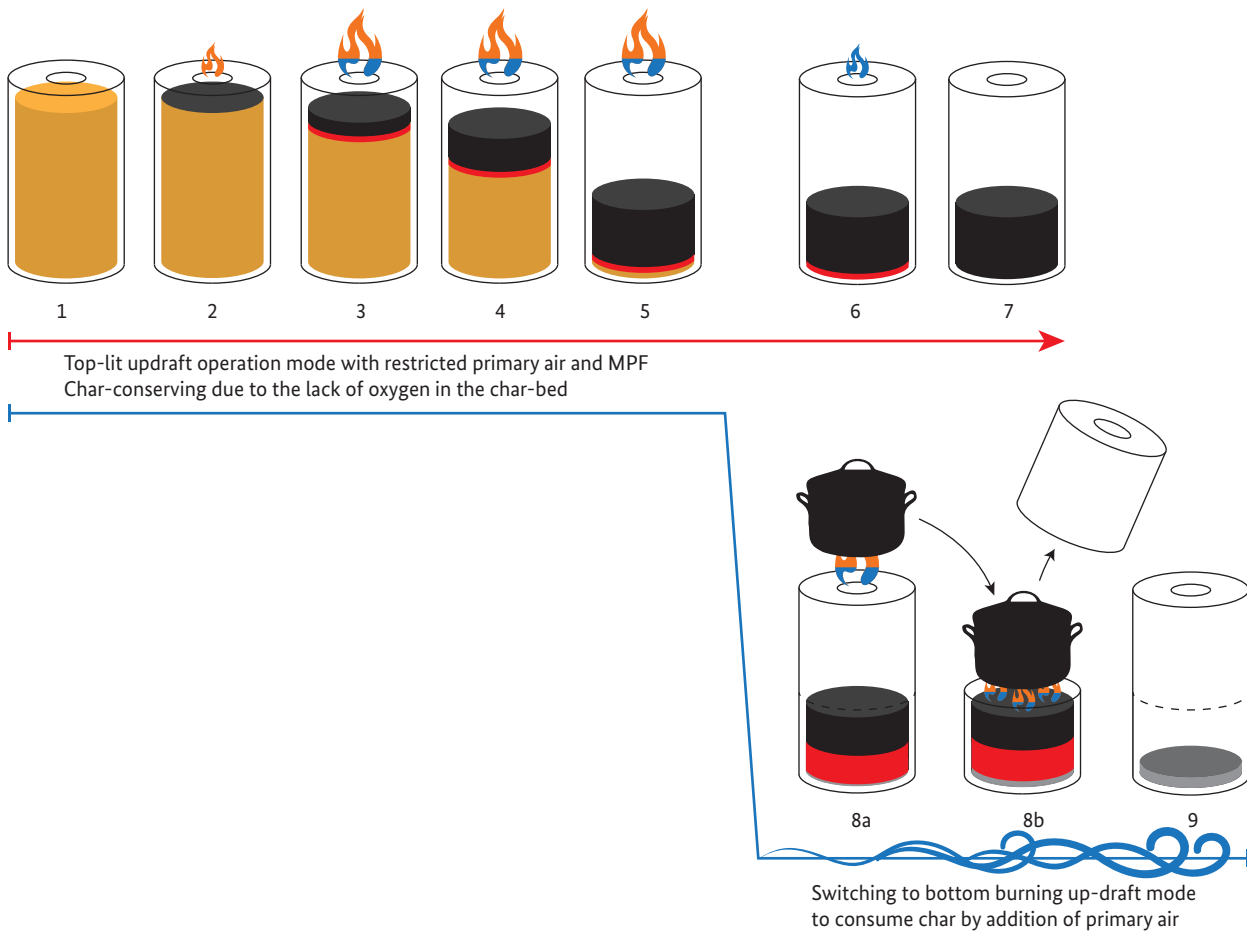



1

Dry fuel is loaded into the reactor. The fuel does not get moved (*fixed-bed*) and only shrinks in volume. Fuel is ignited at the top of the column with either a solid or liquid fire-starter or a small wood fire. Primary combustion air travels upwards through the column of fuel from the bottom.



2

The initial heat of the fire-starter begins to pyrolyse the upper layer of the fuel-bed; the surface turns black and the first gases are created. They combust in a small flame once mixing with secondary air at top. It is crucial that the entire surface of the fuel is evenly lit so that the MPF can start progressing downward as a horizontal front.

An initial top layer of charcoal is created. The very limited supply of rising oxygen from the restricted primary air flow encounters abundant combustible pyrolytic gases coming out of the dry biomass fuel. Any oxygen available is used in the oxidisation of a small quantity of pyrolytic gases, just enough to provide the heat required to keep the pyrolysis reaction going. Small flames and glowing char form the MPF, the migrating pyrolytic front within the fuel bed. It is indicated by the red line below the char.



3

Created char accumulates above the pyrolytic front, prevented from combusting due to a lack of oxygen. As there is not enough air to accomplish char gasification, char will not combust at this point and the glow subsides once all the oxygen in the rising gas flow is consumed. The hot inert gases (mainly nitrogen) that remain sweep the created pyrolytic gases and water vapour through the hot char and into the secondary (main) combustion zone above the fuel bed. The pyrolytic gases are tarry, long-chain hydrocarbons that, if not burned, form a thick smoke.

Combustion is completed as the hot gases get mixed with secondary air in the designated combustion zone. The pyrolytic gases are burnt in a separate and very clean flame, which appears to come out from the sides of the container. In actual fact, hot gases coming from below meet the oxygen entering the combustion zone from the side either through holes or slits in the sides in the reactor wall.

The yellow flame is a typical diffusion flame in which air is mixed into the flame after ignition.

A flame on top is now fully established; the shape of the flame can be influenced by the presence of a concentrator or a diffusor plate.



The MPF continues to radiate heat downwards into the cold fuel-bed, keeping the pyrolysis moving down through the fuel column. The flame on top will remain steady unless the primary air supply is changed. Increased primary air-flow (assisted with a fan or a tall riser / chimney) will result in faster progression of the flaming pyrolysis front down the column of biomass and also in higher temperatures within the pyrolysis zone. More primary air also increases the amount of burnable gases, thus increasing the heat-output and fire-power of the TLUD.

In a typical TLUD, the pyrolysis front moves downwards at 5 to 20 mm per minute depending on the nature of the fuel and the amount of primary air. In the case of standard 6 mm diameter highly densified wood pellets with a natural draft, it can progress as slowly as 1 mm per minute. This means that a stack of 60 mm would last 1 hour, 120 mm 2 hours, 180 mm 3 hours, and so on.

The duration and temperature of the pyrolysis process will impact the characteristics of the created char.



As the MPF approaches the bottom of the fuel-bed, the flame size remains constant, indicating uniform heat output. It can, however, produce a small spike in gas production when radiant heat is reflected back from the grate.



The MPF has now reached the bottom, and there is no more fuel to pyrolyse. The flame diminishes as the last gases reach the combustion zone. The transition between the two phases is quite distinct, changing from a characteristic yellow-orange flame (from burning tarry gases) to a smaller, bluish flame that denotes the burning of carbon monoxide. The glow of the MPF continues for a moment but also diminishes as the temperature drops and the small flames caused by partial gas combustion within the fuel-bed extinguish.



If no additional primary air is added, the embers of the MPF at the bottom of the char-bed eventually cease to glow. The remaining small amount of CO created from the hot charcoal is not sufficient to sustain a flame in the combustion zone. The flame dies down naturally and the char starts to cool off unless a considerable amount of primary air is entering by leakage.

This is the end of the top-burning TLUD operation mode. The char has shrunk to about half of its original volume and about 20-25% of its original mass. If the char is to be conserved for further use, it can now be unloaded and quenched.



Photo 2.2
A stack of woodchips in a fuel container made of heat-resistant glass lit on top, directly after lighting



Photo 2.3
Uneven progression of an MPF due to voids in the fuel-bed increasing draft

2.4.2 Switching from TLUD to BBUD to burn char

If the user does not want to conserve the char and prefers to use the extra fuel to continue cooking, the char can be burnt to ash by increasing the primary air that reaches it. This can be done if the structure has air intakes that can be opened, such as a door or if a fan is added.

In this case, the same TLUD device can function as a charcoal burner and the mode of operation can be switched to bottom-burning updraft mode (BBUD) as shown in steps 8 and 9 in *Figure 2.6*.

The direction of fuel consumption is now reversed: the pile of charcoal will burn from the bottom and consume the fuel descending from above until only ash is left. With an increased rate of air supply the device turns into a forge. The highest temperatures occur where air reaches the hot char, typically at the grate at the bottom of the charcoal-bed or along air-holes on the sides, as shown in the *Photos 2.4* and *2.5*.



Photos 2.4 + 2.5
Char created from corn cobs in a gasifier can still be used to continue cooking

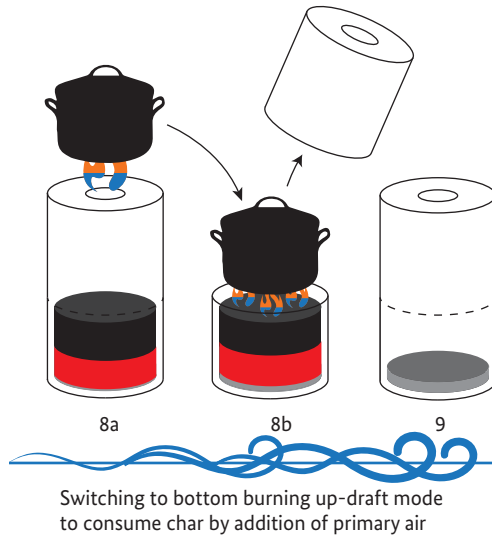

Close-up of Figure 2.6
Bottom-burning
up-draft mode for
burning char

Temperatures can easily exceed 1,000°C, indicated by an orange glow of the char. This puts extreme stress on the material at the bottom of the reactor and can damage and even destroy the entire unit.

For fan-assisted stoves, the fan should preferably be switched off or removed to avoid destruction at the end of the pyrolysis phase.

On the other hand, a low and hot charcoal-bed in the reactor allows for continued operation in BBUD mode with modest refuelling of raw fuel from the top.

2.4.3 Double-decker TChar concept to make char for immediate use while hot

If the reactor does not have a fan or door to increase primary air supply, users often transfer the hot char into a special charcoal stove to continue cooking. Pouring out hot embers from a top-fed stove can, however, be quite dangerous, as it has to be turned upside down.

This problem has been resolved through a new design named TChar (from TLUD charstove). This groundbreaking innovation emerged during a TLUD stove camp in Uganda in June 2011 and was based on feedback from users.

A TChar consists of a gasifier reactor (T-top) placed on top of a charcoal stove (T-base). This allows the top section to be lifted off (as visualised in step 8b in [Figure 2.6](#)) once the pyrolysis phase is complete and the biomass has been converted into char. Gravity keeps the hot char in the lower part of the reactor – which is specifically designed to burn charcoal – without the need to turn it over. Additional references on the TChar concept can be found in the *Further reading section* at the end of this chapter.

Users particularly liked the following advantages of the TChar concept:

- charcoal can be made by the users themselves from biomass that is within their reach; they can save money as they don't need to buy charcoal
- TChar produces heat immediately after being lit
- vigorous stirring of pots towards the end of a cooking process can be done on the lower T-base once the T-top has been lifted, increasing stability and safety
- the pot sits closer to the radiating char in the second phase
- inexperienced cooks (e.g. bachelors) really like the design for its ease of use and extended operation time.



Photos 2.6 + 2.7
TChar loaded with bamboo to heat bathwater with low-grade fuel



Photo 2.8
Lifting up the top part; no need to turn the hot stove over ...



Photo 2.9
... gravity allows the char from the bamboo to fall into the TChar-base



Photo 2.10
Roasting potatoes in the *baking tray* underneath the charcoal

TChar as a *bachelor stove* in Malawi

The TChar concept became very popular among single men in Malawi, like Felix Chauluka, a student living on campus in Chiradzulu:

“The TChar is ideal in the morning before going to school. I can use home-made briquettes, small twigs or maize cobs as fuel, so I do not have to buy charcoal and get my hands dirty with it. The stove lights up very quickly and I can immediately put on the pail with water for my morning bath. Once lit, the stove does not need attention. My bathwaters heats up on its own while I get a pot ready with sweet potatoes or cassava for my breakfast. This pot goes on the stove and my breakfast gets cooked while I take my bath. By the time the potatoes are ready, I put a small pot with water on for my cup of tea. I have learnt to metre my fuel to adjust the burn-time of the stove to the 30-40 minutes I need for the bathwater and breakfast. Normally the fire goes out by the time my tea water has boiled. Then I lift off the top of the TChar and fry some eggs or roast some sausages on the glowing char. Without having to stoke the fire or re-ignite, my breakfast is ready, I am also ready to eat! My neighbours borrow the stove to heat bath-water for their family.”



Photo 2.11
Felix and his
bachelor stove



Photo 2.12
Neighbours
heating bathwater

There are various ways to apply the TChar concepts. One is merely to sell a T-top as an accessory that fits atop commonly used charcoal stoves already in the household (see [Photo 2.13](#)).

Another option is a twin-set of T-top and T-base that both have their own handles and pot-rests, e.g. the Butembo stove described in [Chapter 4.3](#).



Photo 2.13
Fried eggs
for breakfast



Photo 2.14
T-top atop a conventional charcoal stove
in Malawi

2.4.4 How to optimise a gasifier according to the *three T's of combustion*

Some design features of gasifiers can be optimised to enhance complete combustion once the factors *time, temperature, and turbulence* are understood. The same applies to the type of fuel used: dry fuel works best. Read more on the influence of fuel properties in [Chapter 3](#).

- **Time** for the reactions to take place can be increased by extending the area and length of the hot combustion zone, e.g. with a small chimney or a *riser*. This increases the time needed for gases to pass through the area, resulting in more oxidisation.
- *Fire follows air*: Sufficient secondary air supply into the combustion zone can shorten flame lengths and enhance complete combustion within the flow-path of the gases; it can also prevent unburnt fuel (*smoke*) from exiting the stove structure.
- *High velocity of the gases decreases their resident time in the combustion zone*: using dry fuel minimises the volume of gas resulting in less water vapour in the gas and reduced gas volume passing through the area.
- **Temperature** should be high enough to make reactions happen and avoid *emissions*. In order to oxidise poisonous CO to CO₂, temperatures above 600° C are needed. In colder environments, this reaction does not happen, allowing for harmful CO to leave the combustion zone without having reacted to CO₂. Fuels with high moisture content should be avoided as they can cool temperatures below the needed level for combustion. Insulating the combustion zone or pre-heating the (secondary) air supports higher temperatures.
- **Turbulence** to obtain appropriate mixing of combustible gases with oxygen is crucial for the molecules to mix with one another and react: forced secondary air or physical obstructions in the gas flow path – like a concentrator or reducer ring – enhance turbulence. Although turbulence in the gas phase is desirable, the solid fuel bed should not be stirred. Batch-operated TLUD gasifiers emit less PM because the carbon-fraction *soot* is burnt due to optimised combustion. Furthermore, as the fuel-bed is fixed and is not moved during operation, less fine particles are released from the fuel reactor.

2.4.5 How to tune a gasifier to cooking requirements

Possibly the most important aspect to remember in regards to cook-stove technology is that a gasifier burner unit itself is not the *cook-stove*. Rather, it is only the heat-generating element that can be optimised to generate the most heat from a fuel.

Figure 2.7 A stove is a combination of a heat-generator and a heat-transfer structure

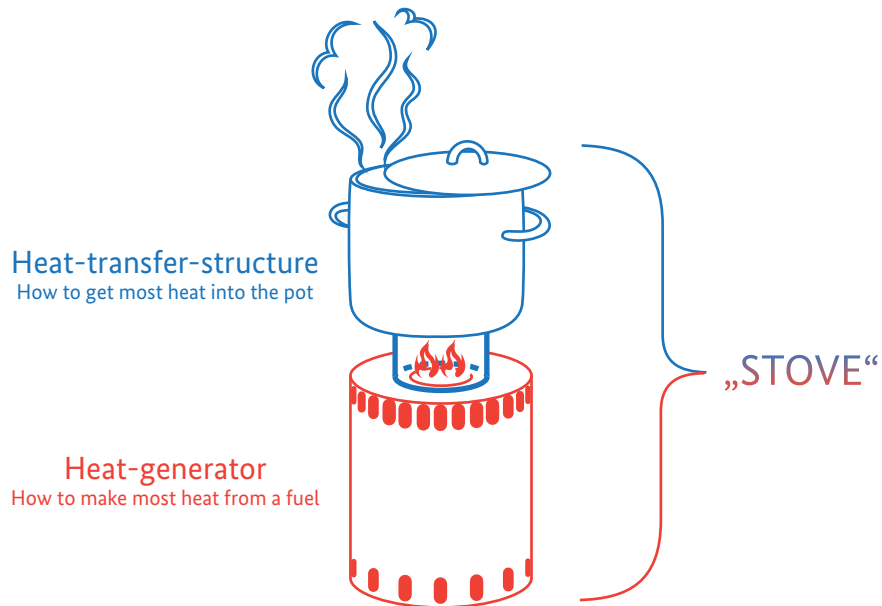

It becomes a *stove* in combination with a structure that transfers the heat into the pot. This usually involves an additional structure that supports the pot above the flames, like a pot stand or an existing stove structure in which the burner unit is fitted.

A cookstove is a combination of parts that work together. [Table 2.1](#) provides an overview of how to tweak the functional parts of a stove in order to adapt it to specific cooking needs and environmental conditions. Please remember that *form follows function* when adapting a heat-transfer structure to suit local cooking habits.

Just as there is no single *world-kitchen*, there cannot be a single cookstove that serves the entire world. The multitude of various needs, desires, customs, materials and fuels are as diverse as the world's cuisines. [Chapter 4](#) presents a selection of gasifier cookstoves from around the world.

Table 2.1 Functional parts of a micro-gasifier and its influence on specific cooking

Feature / factor	Influence on
Diameter of reactor	A smaller diameter will have less surface area so that the pyrolysis front will <i>convert</i> less solid fuel per unit of time into gas than a wider container. If more gas is combusted, fire power increases and more heat is available for the cooking process. Too small a diameter leads to insufficient heat, too large a diameter results in too much power. The appropriate diameter depends on the bulk density of the fuel and the cooking task. As a rule-of-thumb, a reactor with a diameter of 15 cm provides good firepower for cooking with dense pelletised fuels.
Depth of the fuel chamber / height of the stove	The depth of the fuel chamber / height of the stove determines the duration of burning one batch of fuel: a high fuel stack provides more cooking time and less frequent refuelling. The total height of the stove needs to ensure the stability (avoid the danger of tipping) of the stove and respect the ergonomics of cooking (the height at which a pot can still be stirred with ease). The appropriate height will depend on user preferences, how they strike a balance between the convenience of longer burn-times and the usability of the stove. High stoves can be incorporated in an enclosure or combined with a sturdy tripod to avoid tipping.
Handles	Handles ease the act of dumping char. While cool handles increase safety and prevent burns, protruding handles can cause accidents if people knock into them.
Primary air	Primary air supply can be controlled by a variable-speed fan, a sliding door or adjustable openings: more primary air leads to more partial combustion at the MPF, resulting in more gas and heat. The amount of primary air will also determine the rate of char consumption. To suppress char burning and retain the char, primary air must be blocked out completely.
Secondary air	Preheating secondary air enhances combustion and reduces smoke.
Insulated reactor	Keeping the heat in the reactor accelerates pyrolysis reactions, resulting in increased gas generation. It also reduces the risk of burns for users, granted that the outer surface stays cool. However, high heat is likely to cause increased wear & tear to the inside of the reactor.
Accessibility to top of fuel container	Accessibility influences the convenience and ease of lighting, loading fuel and dumping char.
Fuel properties (read more on fuels and their influence in Chapter 3)	Fuel moisture leads to energy loss, poor performance and more smoke. Fuel density matters: A dense fuel has more burnable mass and can create more heat from the same volume of fuel. Size and bulk influence gas flow. Bulky, fluffy fuel burns faster than compact, densified fuel with less air gaps, e.g. pellets.
External factors: Wind, low temperature	Cooling slows reaction speed while wind can disturb the flame in a combustion zone. Both can lead to incomplete combustion and smoke.
Altitude	Low atmospheric pressure at higher altitudes results in less draft and less oxygen in the air. Draft can be increased through the use of a riser or a chimney.

2.5 Nearly as good as gas: performance indicators for gasifier stoves

The global goal of achieving clean cooking has led to a closer look at stove emissions. Jetter et al. (2012) investigated the emissions of different cookstoves in various settings. According to their data, micro-gasifier cookstoves are currently the cleanest-burning option for solid biomass fuels when using low-moisture fuels.

Figure 2.8 Emissions of different stoves with low-moisture fuels at high power

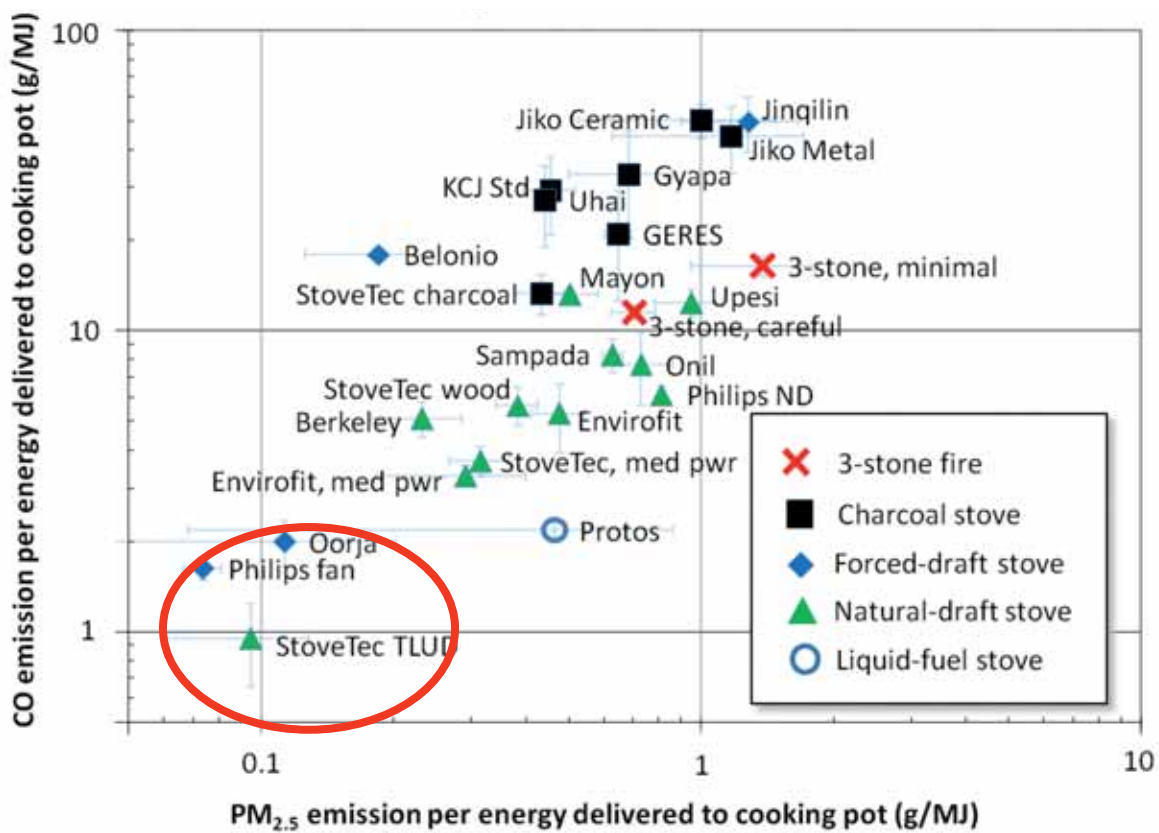

Source: Jetter et al. (2012)

When used with low-moisture fuels, the three stoves marked by the red circle in Figure 2.8. have the lowest emissions of CO and PM_{2.5}. They are all gasifier stoves, namely the StoveTec TLUD (natural draft), the Philips fan and the Oorja stove (also with a fan). As shown by the red oval in Figure 2.9, in the low-power phase, the StoveTec TLUD and the Philips fan stove that are operated on solid wood pellets outperform all other stoves, including a stove operated on liquid fuels.

Figure 2.9 Emissions of different stoves with low-moisture fuels at low power

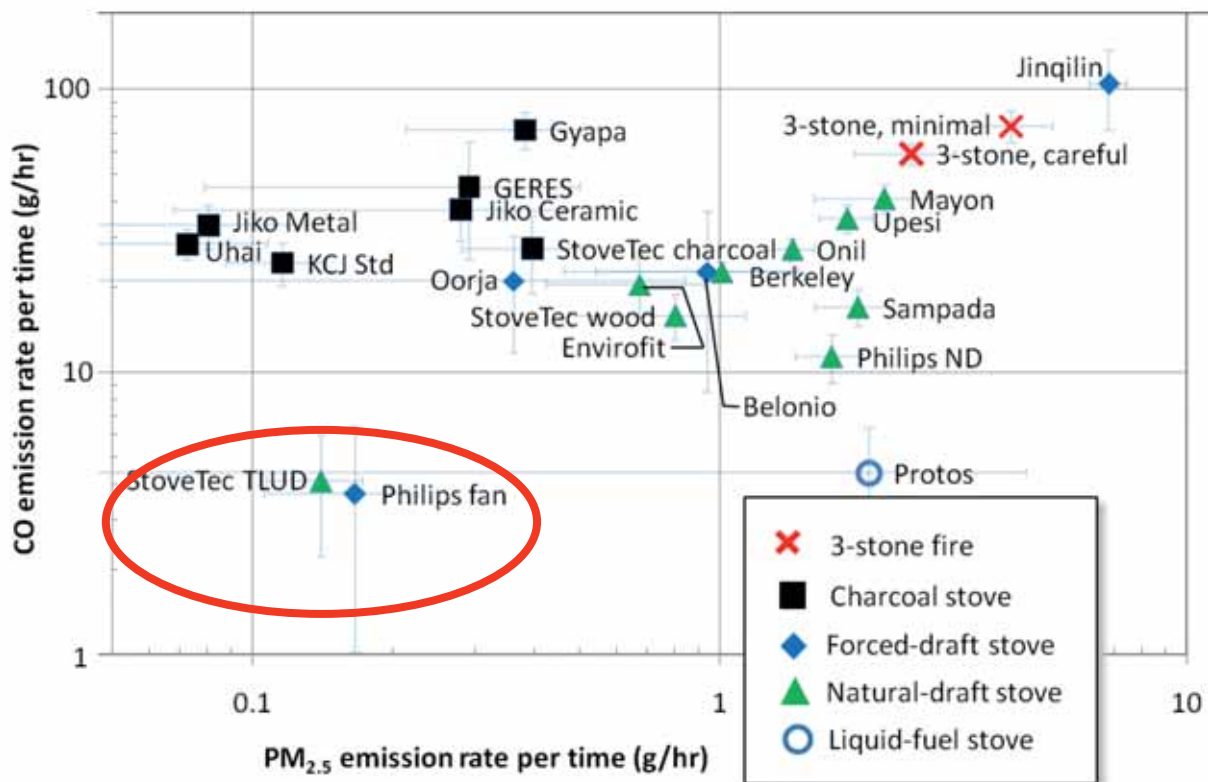

Source: Jetter et al. (2012)

In a comparison of stoves tested for fuel efficiency, Jetter et al. (2002) found that the natural-draft StoveTec TLUD offered the highest thermal efficiency of all stoves by far, particularly when used with low-moisture pellet fuel. The stove was a unique prototype that was never commercialised in this form but was used as a basis for further developments by StoveTec.

Nevertheless, the model has shown the potential of TLUD gasifiers in combination with processed solid biomass fuels to have the lowest emissions and highest-known fuel efficiencies compared to all other stove types included in the test.

The test results by Jetter et al. also laid the foundation for the IWA tiers of performance for cookstove ratings introduced in *Chapter 1*. They clearly show that for solid fuel use gasifier cookstoves are in a class of their own and come closest to the aspirational goals of fossil gas or liquid fuels stoves.

Though it is a welcome development for this edition of the manual that many more testing results were available, comparable data on fuel consumption and emissions are still scarce. Few gasifier stoves have been tested according to comparable protocols. A challenge is that the water-boiling-test protocol that is currently recognised is not well suited for batch-fed stoves. More data will hopefully soon be generated and shared. In 2013, Jetter and the team at USEPA tested additional stoves, among them the gasifiers PekoPe, Mwoto and Vesto described in [Chapter 4](#). Results are expected to be released in 2014.

Read more on the performance of gasifier cookstoves and user preferences in the article by Kirk Smith (2011) *Cooking with gas*.

2.6 Operation and utilisation of micro-gasifiers in cooking

Possessing a device is one thing, but actually using it is another. A stove needs to be convenient and useful to those who operate it. Otherwise, a stove may prove very efficient but will have no positive impact if not put into use. People need to know how to get the best performance from a device and how it may help them address their cooking needs and even reduce their workloads.

As with any cook-stove application, the fuel, stove, pot and the human factor (user, designer, manufacturer) should be taken as interrelated elements of a single system. The following paragraphs provide ideas and practical examples on how to increase gasifier cookstove use and adoption.

2.6.1 How to get most heat into the pot

The hot combustion products should be directed towards the pot to enhance the effective transfer of heat. A pot support structure should keep the pot above the burner unit at an appropriate distance from the gas exit: not too close to the burner unit, in order not to obstruct the flow of gas and quench the flame, and not too far, in order to avoid cooling the gases before they reach the pot. With natural draft stoves, using a concentrator ring at a distance from the bottom of the pot of about 5 cm, or a width of three fingers, have provided good results. Additional features like a pot skirt or wind shield increase heat transfer but might not be practical if pots and pans have handles.

2.6.2 How to light a stove from the top

Starting a TLUD can be tricky as a sufficient temperature needs to be generated all over the entire surface in order to get the pyrolysis process going. Provided that fire starters do not obstruct the updraft through the fuel or trickle down into the fuel-bed, some of these methods and devices can be useful:

- 1) building small bon-fires with kindling on top of the cookstove (least cost, but requires some *fire-literacy*)
- 2) dripping wax from a candle onto the solid fuel (expensive and less effective than liquid starters)

- 3) sprinkling liquid fire-starter (best to measure the liquid and avoid pouring too much) or soaked solids (like twigs, pellets, cotton balls, pieces of cardboard, etc.) onto the solid fuel
- 4) enhancing draft with a lighting cone or chimney, possibly 30-50 cm high.



Photo 2.15
Lighting a bon-fire of small kindling on top



Photo 2.16
Dripping wax from a candle to light a TLUD



Photo 2.17
Metering kerosene with a bottle top before sprinkling it onto the fuel



Photo 2.18
A lighting cone on top of a Toucan TLUD

Kathleen Lask (2013) provides an overview of some of the various options for igniting a TLUD stove, such as with the help of a lighting cone to create draft and pull more air through the fuel-bed. Care should be taken to cover the entire surface of the fuel-bed and block any secondary air holes. Otherwise, more secondary air above the fuel bed than primary air through the fuel bed will be drawn in, preventing the TLUD from lighting. The chimney or lighting cone should be at least 500 mm high and have large handles for safe removal when hot.

2.6.3 How to relight a stove when the flame has gone out

One of the frequent challenges for users is how to cope with the flame of the gas-combustion going out, such as through a gust of wind, and the gas-generator emitting a thick cloud of wood-gas. Surprisingly enough, users interviewed by the authors did not report this as a significant problem; they developed appropriate techniques to relight the fires on their own. Nevertheless, one trick is to introduce a flame just above the secondary air entry, since there is otherwise neither a spark nor enough oxygen to reignite the stream of wood-gas coming up from below. The draft of the gases can be strong enough to blow out a match held on top of the riser. If the riser is detachable or has a small hole on the side, the flame of a match held in front of the hole will be sucked inside by the draft and will usually reignite the flame in the combustion zone.

Tossing a burning twig or a piece of cardboard into the riser may also be sufficient for reigniting the flame.

2.6.4 How to enhance stability and safety

Tall stoves are prone to tipping over when a heavy pot is placed on top of them. A broad base or an independent sturdy structure can provide more stability, especially when vigorous stirring is needed during cooking. An enclosure also reduces the risk of burns to cooks and children, especially when the fuel container gets very hot.

The stove structure itself is often the most expensive part of a stove. It is quite visible and people want it to be aesthetically pleasing. Decorative tiles and attached working surfaces all add to the cost. Fixed pot-support structures can be inexpensively made from local bricks with some rebar laid across (*see example in Chapter 4.2.10*).

2.6.5 How to regulate power and heat-output

The power output of a gasifier unit is generally determined by the amount of gaseous fuel or pyrolytic vapours produced from the solid fuel at any given time.

The burn rate at which solid fuel is pyrolysed to create the combustible vapours largely depends on:

- The peak **temperature** in the fuel container: higher temperatures in the gas-generator will create more gases per unit of time due to a slightly higher percentage of volatile matter that is converted into gases. Moreover, the pyrolysis zone travels more rapidly down the fuel column.
- The available amount of **primary air** strongly influences heat in the reactor and, therefore, the speed and intensity of the pyrolysis processes:
less primary air = less wood-gas created = less conversion of biomass into char.
- The **diameter of the fuel container** directly determines the size of the surface of the pyrolysis front that travels through the fuel: a smaller diameter will have less surface area so the pyrolysis front will *convert* less solid fuel per unit of time into gas than with a wider container.
- The **type and the density of fuel** and how much primary air can pass through it for pyrolysis to take place: bulky, fluffy fuel burns faster than compact, dense fuel with fewer air gaps, e.g. pellets.

If secondary air is increased at the same time as primary air the increased amount of wood-gas can be entirely combusted which will increase the fire-power of the stove.

An abrupt increase of secondary air may blow out the flame in the combustion zone, which will cause all the wood-gas to leave the combustion zone unignited and unburned. This generates a great deal of smoke until the secondary combustion is reignited.

Assisting the air-flow with a fan enhances the performance of most gasifiers. The downside is that a fan requires small amounts of electrical power, which must either be provided by:

- the grid (making the cookstove bound to a socket and a power cord, and dependent on the availability of power on the grid)
- a battery (which needs to be regularly recharged and / or replaced)
- a TEG (which is a temperature-sensitive and costly part that also needs a small battery backup).

Forcing of primary air through the fuel-bed increases the rate of gas generation and thus the power-output of the stove. Forcing secondary air to mix with wood-gas allows for improved mixing and cleaner combustion. Normally, the length of the flame is shortened, keeping the flame better concentrated underneath the pot.

Fans that allow for speed regulation provide the user with an extra convenience in regulating the power output of the stove.

Some gasifiers with forced-air features can regulate the fan speed and thus the air supply. Tom Reed's wood-gas stove (see [Chapter 4.1.6](#)) provides two sockets for the battery pack and has a choice of low or high fan speeds. Other stoves such as the models from Philips, Teri or Paul Olivier, described in [Chapter 4.6](#) have a knob that can regulate power input from an electricity source. With few exceptions like designs by Prof Nurhuda in Indonesia (see [Chapter 4.2.7](#)), most systems cannot regulate primary and secondary air separately even though this would provide additional options for adjusting the performance of the micro-gasifier during operation.

2.6.6 What to do when a batch of fuel has been burnt

When one batch of fuel is consumed, the char needs to be emptied before the container can be reloaded with fresh fuel. This is easier if the structure:

- has handles that stay cool such as wooden handles or large metal handles
- is sturdy yet not heavy
- has a detachable fuel container so that the pot does not need to be moved.

If there is a fan with a power cord, the power supply or entire fan unit should be detachable from the fuel container so that cables do not obstruct the handling of the hot char container.

In order to extend the life-span of a stove, char should never be doused with water while inside the stove. A fan should always be switched off once cooking is finished to prevent overheating by turning the stove into a forge. Hot char should always be emptied as soon as possible to avoid deterioration of the stove material.

Different users value features differently: batch feeding of a stove is seen by some as a clear advantage as they do not need to tend to the fire every 2-5 minutes. Others consider this a disadvantage as the entire container needs to be exchanged and reloaded at the end of the burn cycle. Users can decide on the right tool for their cooking tasks on their own.

2.6.7 The importance of user training

There is stove use and stove abuse: *hardware* alone is not enough when disseminating a new technology. The skills needed to operate the hardware properly are crucial as well.

In this regard, a micro-gasifier is like a bicycle: buying one does not automatically make someone a good cyclist; it takes time before a user can master the technology. During the learning curve most people will fall off their bicycles and get a bit bruised but continue to learn until they feel comfortable and eventually wonder how they ever got along without a bike.

With micro-gasifiers the learning and adaptation curve is similar. The challenge lies in learning how to master all situations, including the difficult ones. Motivated people have done so in the past and will continue doing so in the future. With guidance and the sharing of experiences, learning to master a new technology can be made easier, faster and safer. On the whole, training should to be considered as a *make-or-break* factor for the acceptance of a technology.

Report by Bjarne Laustsen from the design process of the Jiko Bomba stove in Arusha, Tanzania

“Gasifier stoves require some changes in cooking habits, which are difficult to change.

We have experienced that often it is the head of the family who buys such stoves. We can instruct her / him in how to use the stove. However the stove is often left to the house girl to use, but she gets little instruction. The stove then ends up not used or used wrongly. That is a challenge.

Another issue is that for some households the firebox is too small so the stove's burning time is too short. We have plans for producing the stove in several sizes.

We have also noticed that parts of the stove are exposed to high temperatures during use. Mild steel cannot be subjected to such temperatures repeatedly. So there are durability and maintenance issues. I believe that this is a general problem for gasification stoves. We are at present looking into using other type of materials for some parts of the stove.”

User training is of utmost importance for any large-scale introduction of micro-gasifiers. It is best done by skilled knowledge-bearers who can provide initial training to other trainers in a new region. Thereafter, the locals who have learned the skills themselves become the best resource for disseminating the necessary skills further. The challenge is to reach out to the actual users long enough for new practices to be so wide-spread that they become common knowledge. Some experiences regarding user training by GIZ can be found in the Cooking Energy Compendium (*see Further reading*).

2.6.8 The importance of user involvement in the adaptation of stoves

While a burner unit can be similar in different parts of the world, the stove structure needs to suit the local requirements of future users. As such, it is advisable to involve them in the adaptation and design of a stove.

Report by Stefano Bechis on the development of the Aaron stove in Niger (see [Chapter 4.2.9](#) for details of the stove)

“Several experienced local cooks were given prototypes of the Aaron gasifier for cooking a traditional meal. In order to make the Aaron stove as user friendly as possible their observations were considered:

- *The final height is a compromise between the preference of having a ‘short’ stove (which enables cooking in a sitting position) and a minimum height of the stove body at 55 cm (to assure sufficient draft and burn time). As a result, the stove is still considered a little high, but users have come to accept it.*
- *Users that have a fixed place where they use the stove dug a 10 cm-deep hole in the ground to lower the stove height. This had no impact on the functionality of the stove as the bottom is completely closed, and stability is excellent.*
- *The stove was created to best accommodate for the most used pot size. The pot is locked into the pot-rests and does not move, permitting the stirring (even vigorous) of foods without problems. Smaller pots can still fit into the circular shield. Larger pots and frying pans with a handle are supported by iron bars placed across the edge of the pot skirt.”*

If users resist changing from an open fire to an enclosed fire chamber because of the loss of light that brightens the cooking area, using a heat-resistant glass from a paraffin lamp instead of a metal riser can provide light during operation.

2.7 Biomass gasification in a nutshell

Solid biomass does not combust directly. *Biomass Gasification* is the broad term used for the conversion of solid biomass into combustible wood-gas. In a gasifier device, the stages of gas generation and gas combustion are deliberately separated so that they can occur in a timed sequence in distinctly separate locations.

Micro-gasifiers are small gasifier devices that create their own gas from solid biomass and are small enough to fit directly under a cook-pot.

The following table summarises some strengths, weaknesses, risks and opportunities of using micro-gasifier burner units in cookstoves:

Table 2.2 SWOT-analysis of micro-gasifier burner units for cookstoves

<p>Strengths:</p> <ul style="list-style-type: none"> • clean and complete burning of a broad variety of solid biomass fuels • currently the lowest emissions among natural draft cook-stoves • high fuel efficiency due to complete combustion • can use a wide range of local biomass including residues that cannot otherwise be burned cleanly in other stoves • less tending to the fire with batch-loading • ready for use immediately after lighting. 	<p>Weaknesses:</p> <ul style="list-style-type: none"> • regulation of firepower can be difficult. • difficulties of extinguishing gas-generation at the end of the cooking process before all fuel is consumed • inflexibility of cooking times with batch-feeding device that cannot be refuelled during operation • requires fire-starting material to initiate pyrolysis in the gas-generator.
<p>Opportunities:</p> <ul style="list-style-type: none"> • gasifier units can be attached to existing stove structures to broaden the range of usable fuels, giving users the choice of using what is available at the moment • can create charcoal as a by-product of cooking • enables carbon-negative cooking if char is saved and used as biochar 	<p>Risks:</p> <ul style="list-style-type: none"> • if the flame of the combustion unit goes out and the gas generator keeps on producing wood-gas, thick smoke leaves the unit. How people can learn to avoid this risk needs to be assessed as well as how this differs from the same phenomenon in a regular smoky smouldering open fires without a flame.

Outlook

Despite all the progress in micro-gasification, there is probably more that we do not know than that which we do in this relatively young and dynamic field. More research and development work is needed to advance gasifier technologies and fuel processing in order to make clean cooking from solid biomass accessible to all. Open questions include:

- *litre-heaters* to complement existing high-mass stoves such as plancha or space heating stoves
- institutional-sized larger gasifiers, with possible continuous feed
- material and longevity issues of stove components
- regulation options for air to control the power output of stoves, possibly with off-grid solar PV-powered electronics in combination with lighting options for households
- production methods for stoves as well as fuels.

Further reading

- Carregnatò (2012) created an animation how a TLUD burns. See:
<http://www.youtube.com/watch?v=m2Cjt7AiZJY>
- GIZ (2011): Small-scale Electricity Generation from Biomass Part I: Biomass Gasification. Available:
<https://energypedia.info/wiki/File:Gtz2010-en-small-scale-electricity-generation-from-biomass-part-I.pdf>
- These three papers provide a good introduction to the TChar concept:
<http://www.drtilud.com/2012/08/02/tchar-tech-paper-series>
Note that two of the papers also have Italian translations available.
- In this video, Paul Anderson explains the potential of a TChar to create charcoal in urban areas accustomed to cooking with charcoal, e.g. Haiti. It also displays various models of T-tops and T-bases:
<http://www.youtube.com/watch?v=7A-xxeXxeqI>
- A variety of videos visualising TLUD micro-gasifiers in action can be found on YouTube. The following link provides a good overview of a TLUD and its operation by Paul Anderson:
<http://www.youtube.com/watch?v=SaeanoWZE7E>
- Further information and the compilation of micro-gasification terminology by Paul Anderson can be accessed at:
<http://www.drtilud.com/2013/11/12/micro-gasification-terminology> or www.drtilud.com/resources
- Many more topics to explore can be found at:
<http://www.drtilud.com/category/tlud-research-and-development>
- Insights into the development process of a rice-husk burning stove in Chad can be found in the thesis by Vitali, F. (2012) on Appropriate solutions for cooking energy at household level in the Logone Valley (Chad-Cameroun), submitted at University of Brescia in 2012:
http://issuu.com/paolarosa/docs/tesi_vitali__f__2012__phd_thesis__

General resources

- The Cooking energy Compendium by GIZ HERA on energypedia contains valuable information based on many years of experience by GIZ:
https://energypedia.info/index.php/GIZ_HERA_Cooking_Energy_Compendium
- Find a section at https://energypedia.info/wiki/Cooking_with_gas_from_biomass dealing with wet biomass (biogas) and dry biomass (micro-gasifiers).
- Berkeley Air Monitoring Group (2012): Stove Performance Inventory Report prepared for the Global Alliance for Clean Cookstoves has information about many stove types:
http://www.cleancookstoves.org/resources_files/stove-performance-inventory-pdf.pdf
- The site for Improved Biomass Cooking Stoves <http://stoves.bioenergylists.org> is another fountain of compiled stove-related wisdom. The same team manages a site dedicated to biochar issues:
<http://biochar.bioenergylists.org>
- The International Biochar Initiative has its own section dedicated to biochar-producing gasifier stoves:
<http://www.biochar-international.org/technology/stoves>
- Read about the active Italian network focusing on gasification stoves for biochar production:
<http://fuocoperfetto.altervista.org>

Solid biomass feedstock and fuels for micro-gasification

3.0

3.0 Solid biomass feedstock and fuels for micro-gasification

3.1 Factors influencing the fuel properties of solid biomass

Micro-gasifiers can be used to effectively realise the value of a wide range of renewable dry solid biomass residues as fuels. The options go beyond conventional firewood sticks and charcoal to residues that do not result in the destruction of timber or other valuable natural resources. However, the fuel used should not compete with resources necessary for food production such as land, water, labour, and the like, nor should it compete higher value uses such as timber for construction.

Micro-gasifiers have the distinct advantage to being able to utilise even small fuel sizes that are otherwise too small to be burnt in other stove models, e.g. typical rocket stoves.

A fuel used in a gasifier stove should be reasonably **uniform** in order to prevent blockages and unequal movement of the pyrolysis front as this may create smoke. Standardised (processed) fuels make the performance of the fuel in a stove even more reliable. Fuel levels should be kept below the point at which secondary air enters so as to enable the free flow of air for proper combustion.

To achieve optimal fuel use and combustion efficiency, the solid biomass fuel should:

- 1) Be **dry** with moisture content preferably below 20%. High moisture contents result in less stable stove operation and decrease the available energy output of the fuel since more energy is needed to evaporate the moisture. Moist fuel can hinder proper operation of a stove.
- 2) Be slightly **chunky** to allow for air/gas passage. Particle size should exceed 4 mm. For finer feedstock like sawdust and rice husk it is advisable to use a fan-powered micro-gasifier with forced convection to enhance and control the flow of air.
- 3) Have **particle shapes** that enable convenient loading of fuel into the container. This includes easy stacking and the ability to easily pour fuel chunks into the container.
- 4) Have relatively **uniform particle size distribution** to avoid compacted zones or oversized voids within the fuel container that could prevent the uniform progression of the pyrolytic front through the fuel-bed.
- 5) Have sufficient **energy density** in order to balance heat output of the *burnable mass* (inside a given fuel-container volume) with cooking duration and refuelling efforts.

General issues regarding the choice of solid biomass fuels to be considered:

- Fuel must be economically available in the long-term.
- Fuel must be convenient to use and suitable for its intended purpose.
- Fast-growing fuels should not negatively impact the biodiversity of the locality or compete with resources necessary for food production.
- The supply of any biomass should be sustainably managed so that it can remain a truly renewable energy source.

- The fuel should not contain or release any toxic or harmful substances. In general, any previously living material is non-toxic when combusted but some fuels may have been treated with toxic substances for a previous use – such as treated lumber for insect and rot resistance. Such treated materials should be avoided, especially in cooking applications in which humans are often in close proximity of the combustion gases.

Multi-purpose plants are ideal resources for fuelling gasifier stoves. There are numerous examples of multi-purpose plants that develop woody or fibrous stems with optimal fuel properties; these include pigeon peas, millets, flax, sesame, moringa, castor, jatropha, sesbania, tephrosia, bamboo, switchgrass and miscanthus. Many *anti-desertification plants* suitable for restoring vegetation cover in arid areas can also be a good source of biomass fuels (*please see the Further reading section*).



Photo 3.1
Woman in Malawi carrying pigeon pea stalks to her homestead;
Pigeon peas (*Cajanus Cajan*) provide both food and fuel



Photo 3.2
Pigeon pea stalks as a gasifier fuel for cooking:
easy to break by hand or cut with a machete

3.1.1 Moisture content has negative effects on fuel economy and emissions

Moisture reduces the net usable energy output of a fuel. Based on a comparison of two 2 kg pieces of wood, *Figure 3.1* illustrates how energy is *wasted* in fuels with high moisture contents. The left piece is oven-dried wood (theoretically assumed to contain 0% moisture), resulting in 2 kg of pure dry wood. The right piece is freshly-cut wood (with 50% moisture) which means that there is only 1 kg of pure dry wood and an entire 1 kg of water.

It takes up to 3.21 MJ of energy to evaporate one kg of water in the process of heating the fuel up to the needed pyrolysis temperature of around 400° C from an ambient one. This takes into account the fact that water vapour is also heated to the same temperature as the wood-gas. The energy required to heat the water vapour is, in turn, not available for cooking. This means that the remaining wood-fuel that can be used as the source of cooking energy is only half as much compared to that of a dry piece. It is better to avoid using wet fuel and allow the sun to dry it rather than unnecessarily waste energy on evaporating water.

Figure 3.1 Moisture reduces the net usable energy for cooking

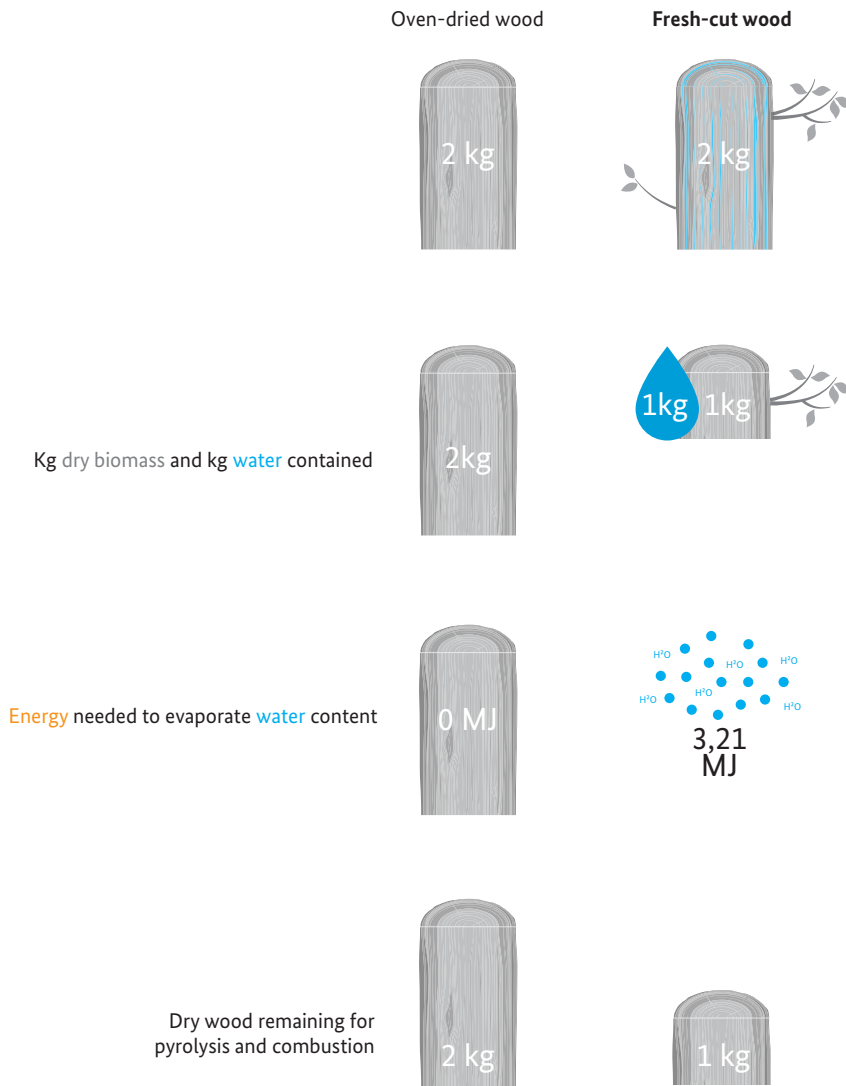

However, oven-dried fuel is not a viable option for many households. Properly air-dried fuel can, however, achieve a moisture content of between 8% - 20%.

Besides the lower energy output, fuel with high moisture content has other disadvantages such as:

- Lighting wet fuel is much more difficult than lighting dry fuel.
- Moisture from the fuel cools the flames. Evaporated steam mixed with the combustible gases acts as a fire-extinguisher leading to incomplete combustion as well as smoke.
- Micro-gasifiers with a migratory pyrolytic front (MPF) – such as TLUDS – have limited tolerance for wet fuel; excessive cooling might extinguish the flaming pyrolysis. When this happens, the *engine* of the wood-gas production comes to a halt and the micro-gasifier regresses to a slower oxidation mode known as *smouldering pyrolysis*.
- Allo-thermal and retort gasifiers, in which pyrolysis is only induced by heat in the total absence of oxygen, are better suited at handling moist fuels. They do, however, lose fuel efficiency on account of the energy expended during the fuel-drying phase inside the retort.

Quantifying the effects of high moisture contents on emissions performance still remains an open issue for further research.

3.1.2 Particle size impacts fuel performance and gas flow

The size of the fuel particles inside of the fuel-bed influences how easily gases can flow through the fuel-bed, be it incoming air or outgoing wood-gas and char-gas. The size of the fuel also dictates how fast heat from the flaming pyrolysis progresses down the fuel stack. Size and shape are generally not critical for a stove's operation but the dimensions must remain within an acceptable range so that proven stove designs can be used without modification. Fuel types not initially intended for a certain stove need to be tested and the operating conditions adjusted to the particular properties of that new fuel source.

Which fuel size is too small?

In general, granular and *chunky* material enables an appropriate and steady flow of gas through the fuel-bed in natural draft devices.

Particles that are too small will block the gas-flow, and particle sizes of 6 mm and greater have proven to work best. The dimensions should preferably lie between 6 x 6 x 6 mm and 60 x 60 mm x the height of the combustion chamber. A large briquette or a fuel bundle can be placed in the combustion chamber vertically.

The restrictive effect of fine particles like sawdust or rice husk on gas-flow can be overcome either by forced convection via a fan or blower or (less desirably) with more draft through a tall chimney.

Which fuel size is too large?

Too large oversized chunks of fuel create several problems:

- Thick objects make the pyrolysis take longer to reach the centre of the biomass particle. The initial pyrolysis leaves behind a layer of charcoal that actually insulates the centre of the particle.
- Oversized chunks create large gaps between the fuel, which are then filled with air under normal conditions. Unrestricted air-flow might lead to excessive primary air in the fuel-bed causing an increase in partial combustion of the MPF. This results in a rise in temperature that might damage the fuel container and also lead to a higher conversion of char to ash.
- The MPF does not progress evenly down through a fuel-bed comprised of larger particles. This often results in incomplete carbonisation of the fuel.

3.1.3 Particle size distribution impacts gas flow

Particle size distribution defines the *porous space* between the fuel chunks and, in turn, the ease of gas-flow. Gas will flow into *open corridors* that are not blocked. If fine particles block the gas passage in a particular part of the fuel bed, it will find an alternative path through areas with larger gaps between the fuel chunks. Some call this the *vertical channelling* effect. It leads to a highly uneven progression of the MPF, likely result in smoke and incomplete fuel use.

When large chunks create cavities between them with finer particles resting above, the finer ignited material can fall into the cavity beneath the pyrolysis front. This causes the MPF to split into two zones, causing an abrupt increase in gas production that often cannot be combusted with the secondary air on hand. The result of this is undesirable smoke.

Generally, initial difficulties related to fuel selection and loading are soon overcome when local people gain experience and have their own preferred fuels and procedures.

3.1.4 Particle shape impacts the convenience of fuel handling

The fastest and most convenient way to load fuel is to pour it into a stove. This avoids the tedious and time-consuming task of carefully packing the fuel into the container by hand. For this to happen, the fuel must be able to freely flow out of the storage container and settle into the fuel container without creating large cavities.

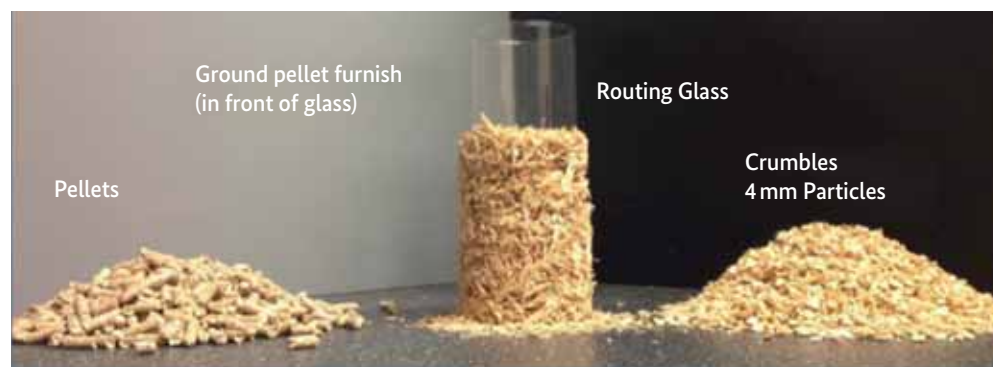

Photo 3.3
Flowability of fuel depending on particle shape (P. Means)

As illustrated in *Photo 3.3*, pellets have the ideal dimensions for small micro-gasifiers; though their length varies per batch, they have uniform diameters and a round shape with a smooth surface that allows them to be poured more easily. Recently, a new and less energy-intensive method for creating Crumbles® as a micro-gasifier fuel with good pour characteristics was developed by the US-based company Forest Concepts. Particles with pointed edges or long fibrous strings do not flow freely and do not adapt to the shape of the fuel container.

Longer segments of fuels can be placed (rather than casually dropped) vertically into the fuel container. Examples include pieces of bamboo, bundles of grass, and straight pieces of stick-wood. These vertical piles often leave many long channels for primary air to pass through. In such a case, a second type of fuel that is smaller should be added to the top and then (usually with some shaking) loosely fill in these channels, preventing any ignited fuel from dropping to a lower position (see *Figure 3.2*). However, such a distribution of fuel particles can also have the undesirable effect of blocking air-flow and causing problems with ignition.

On the other hand, reports from Vietnam show that covering densified pellets with a layer of fine rice husks can be used to slow down gas-flow in a fan-assisted stove.

Figure 3.2 Small fuel added on top of vertically stacked wood

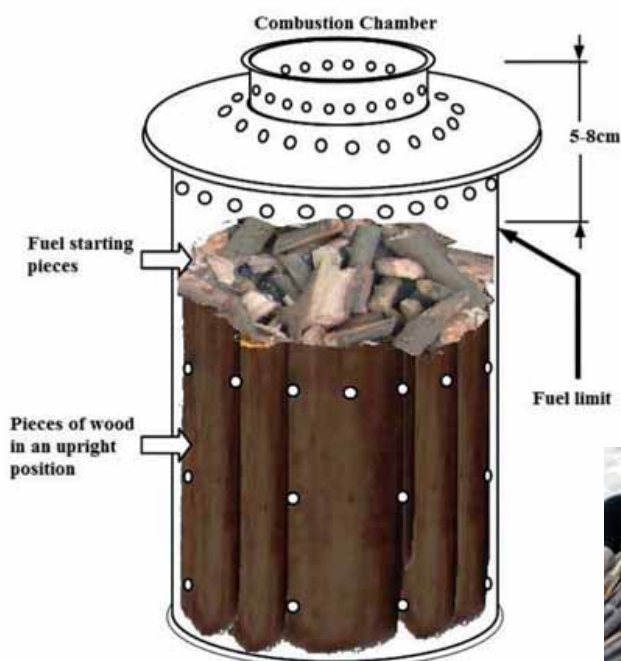

Photo 3.4
Vertical stacking of bamboo in Malawi

3.1.5 Fuel density impacts fire-power and burn-time of a fuel-batch

The density of a material usually relates to *mass per volume*, measured, for example, in kilograms per cubic litre or per cubic metre. However, in the case of fuel as an energy source, the term **fuel density** is often used to relate to the **available energy in a fuel based on its weight**. It indicates the amount of burnable carbon material and unburnable substances such as water and solid minerals (ash content) per kg of a fuel. This **energy value** of a fuel is commonly expressed in Megajoules per kilogram (MJ/kg) or as BTU per pound in the USA.

Energy values mostly vary due to differing levels of moisture and unburnable components (*ash*) in the fuel feedstock. If the fuel is moist, it will have additional mass (be heavier) in relation to its combustible components, and the total energy value will be lower on account of the energy required to evaporate moisture held within.

Remember:

Solid density = Weight of 1 solid m³ of fuel when it is compressed into a solid block without air gaps (equivalent to grams per litre).

Bulk density = Mass of fuel that can fit into 1 litre volume of a fuel container.

Energy per weight (or technically per mass) = Net energy value (lower heating value) or the energy yield of 1 kg of fuel that has been combusted completely.

Energy per volume = Amount of energy that can be attained from the fuel loaded into a fuel container per litre volumetric capacity (without compressing the fuel).

Did you know?

A single pellet has a solid density that exceeds the density of water (1 kg per litre). Thus it is *heavier* than water and sinks.

Loose rice husks, milled miscanthus and straw are agricultural residues with a similar bulk density of 80 - 100 g per litre. They occupy 22 times the volume of 1 litre of fuel oil and 6 times the volume of straw pellets in order to deliver the same amount of energy. A fuel container with a volume of 1 litre can accommodate approximately 100g of loose rice husks or 600g of densified rice husk pellets. This means that in order to obtain the same amount of energy from loose rice husks as from densified pellets, the same fuel container would either need to be refilled 6 times or it would need to be made 6 times larger, requiring more material and increasing costs.

All things equal, the energy output or fire power within the same combustion chamber will be considerably lower.

The relation is simple:

Less mass to burn = less energy output = less burn-time for one batch-load of fuel.

Figure 3.3 visualises the magnitude of these differences in bulk density. Each column has the same energy content and represents the volume needed to obtain an equivalent amount of energy as from one litre of fossil heating oil. The values are based on the following moisture contents: 5.1% for mineral coal, 10% for pellets, 15% for all other air-dried biomass.

Figure 3.3 Energy per volume of renewable resources compared to fossil oil

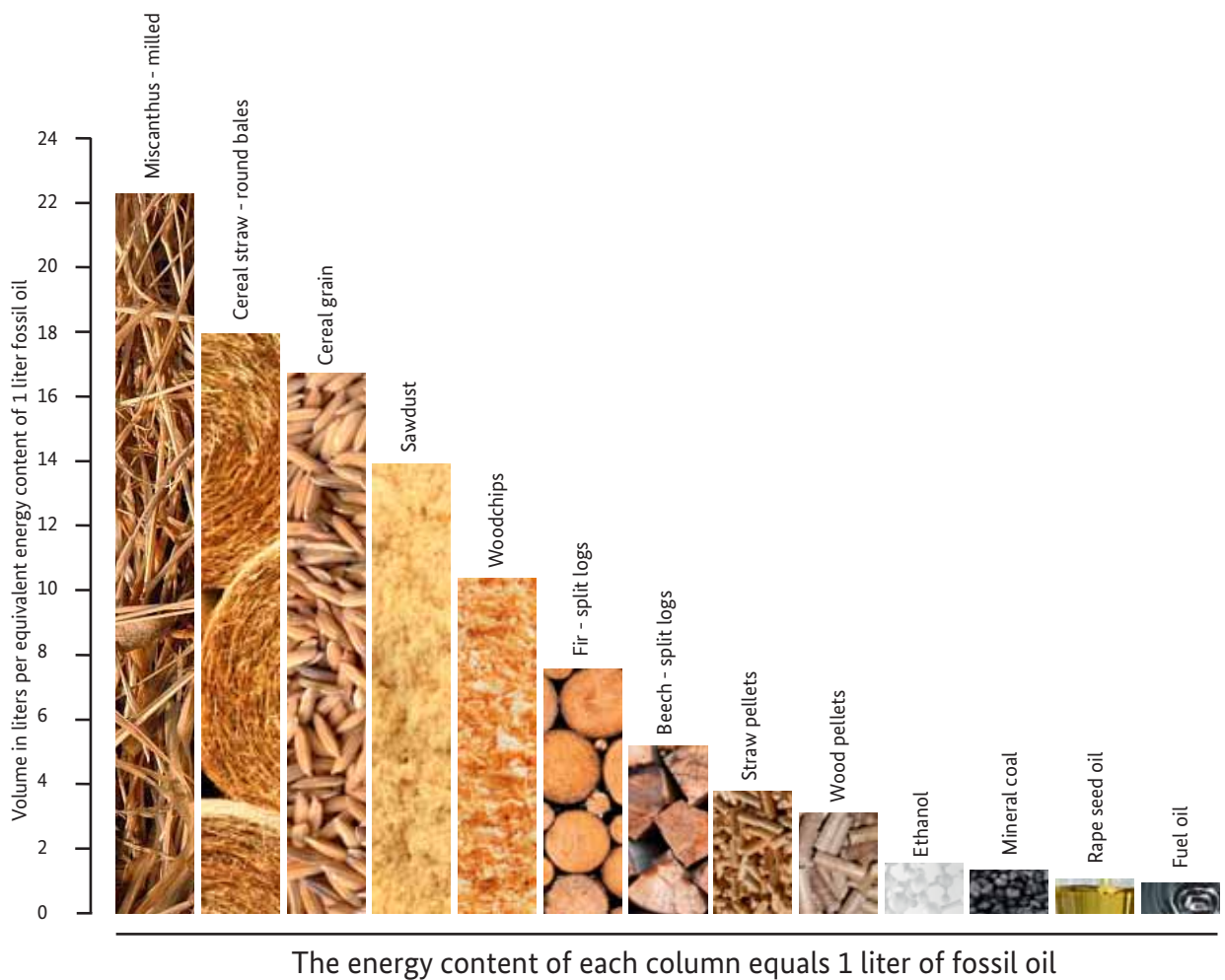

Source: adapted from Technology and Support Centre (TFZ) (2013)

Air-dried wood with 15% moisture content has an average energy content of 16 MJ/kg. Silica functions as the skeletons of plants and retains their strength and elasticity. For example, bark, bamboo, straw and husks all have a high silica content that does not burn. Thus, these biomass fuels have relatively low energy contents and a large amount of ash that are left over after combustion. Biomass with certain oil contents such as nuts and fruits attain higher energy values though these never exceed 36 MJ/kg, which is the heating value of 100% pure plant oil. Depending on the content of ash and oil, the energy content of air-dried solid biomass ranges from between 12 to 18 MJ/kg (if water content is not taken into account).

Figure 3.4 Equal power output from different sources

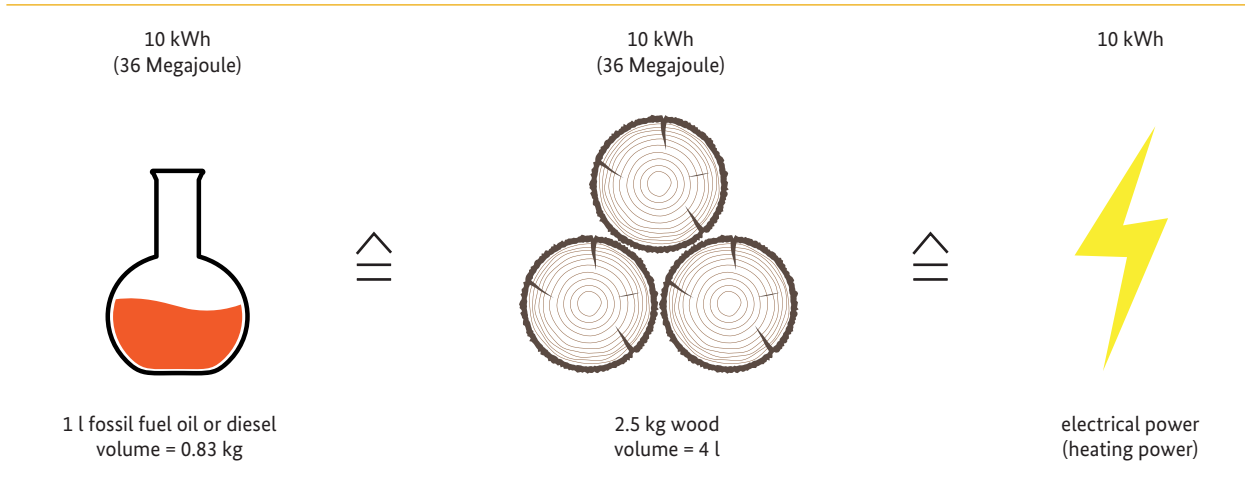

Source: adapted from Technology and Support Centre (TFZ) (2013)

Figure 3.4 depicts how diesel, wood and electricity relate to each other in terms of energy: 0.83 kg diesel is equivalent to 2.5 kg of dry wood or 10 kWh of electrical power.

In a nutshell: The relevant questions for someone operating a stove include how much power and heat can be generated at any given time, over the course of the entire cooking cycle, and per batch of fuel. This *how much cooking can be done with one fuel load* is especially important for batch-operated micro-gasifiers.

Net energy yields from a batch of fuel loaded into a container greatly depend on the type of biomass, its moisture content, its size and shape, the way it is stacked and the resulting bulk density of the fuel.

Low-grade biomass residues with high volumes can provide better energy yields in a gasifier if they are dried, properly sized, compacted and densified.

3.2 How to get appropriate solid biomass fuels for micro-gasifiers

Some biomass is *ready-to-use* in a micro-gasifier. For other feedstock, processing – such as drying, sizing and densification – might be required to prepare the biomass feedstock for optimal use as a cooking fuel in a micro-gasifier.

Solid biomass for cookstoves can be broken down into three obvious sizes: too small (requiring *up-sizing* to make larger chunks like briquettes), *just right*, and too large (requiring it to be cut down). Processing solid biomass fuels often seems cumbersome and expensive; however, it should be put into perspective compared to the processing needs of liquid fuels, e.g. in oil refineries and distilleries. It is reasonable to expect local supply industries for solid biomass fuels to substantially grow and mature as gasifier devices become more widely used.

Feedstock that is ready to use without major processing

The list of usable feedstock is nearly endless and depends on the types that are readily available in a particular location. *Table 3.1* provides some ideas about where to look for appropriate feedstock. Municipal by-products are not recommended for use in micro-gasifiers for cooking or space heating due to their high variability and the presence of potentially toxic ingredients, such as used motor oil and discarded batteries.

Table 3.1 Unified Bioenergy Terminology

		Woody biomass	Herbaceous biomass	Biomass from fruits and seeds	Others (including mixtures)
		WOODFUELS		AGROFUELS	
Energy crop		- energy forest trees - energy plantation trees	- energy grass - energy whole cereal crops	- energy grain	
Byproducts	direct	- thinning byproducts - logging byproducts	crop production by-products: - straw		- animal by-products - horticultural byproducts - landscape management byproducts
	indirect	- wood processing industry byproducts - black liquor	- fibre crop processing byproducts	- food processing industry byproducts	- biosludge - slaughterhouse byproducts
End use materials	recovered	- used wood	- used fibre products	- used products of fruits and seeds	MUNICIPAL BY PRODUCTS
					- kitchen waste - sewage sludge

Source: FAO (2004)

Agricultural residues are generated in large volumes each season and are often discarded as waste. Solid crop residues are the largest source of non-timber biomass fuel: straw, stems, stalks, leaves, husks, shells, peels, lint, stones, pulp, stubble, and the like from all sorts of crops. The largest amounts are derived from annual plants like cereals (rice, wheat, maize / corn, sorghum, barley, millet), cotton and legumes (pigeon peas, bean, soy, groundnut) complemented by woody prunings from perennial plantations like coffee, tea, cacao, olive, fruits (banana, mango, coco, cashew) etc. In the developing world, most agricultural residues and residues from processing of agricultural products are used as fuels in their natural state with limited pre-treatment such as drying and cutting; compacting is rather rare. Compared to wood-fuels, crop residues typically have a high ash content, lower density and shorter burning time. *Table 3.2* presents an evaluation of crop residues.

Table 3.2 Advantages and disadvantages of using agricultural residues as fuels

Advantages	Disadvantages
<ul style="list-style-type: none"> • Agricultural residues are often available free of cost to poor rural families. • Controlled burning in a stove is cleaner and more environmentally friendly than uncontrolled burning. The ash can be taken back to the field and used as plant nutrient. • Agricultural wastes are safer than LPG, which poses some safety concerns for local transport and use. • Easy to handle, transport and store. • Low impact on women's time for harvesting. • Agricultural wastes are often easier to light than wood and charcoal. • Generally require less time for preparation than wood. 	<ul style="list-style-type: none"> • When burnt in open fires or traditional improved stoves, residues can cause extreme air pollution. But they do burn well in gasifier stoves. • They are often bulky and have to be carried to the homes. Storage requires more space inside a house or shelter. • The seasonal availability of crop residues can limit their continuous use. • The burning time is often shorter.



Photo 3.5
A common sight:
Smouldering rice
residues in Uzbeki-
stan. Rice husks are
the most abundant
and underutilised
agricultural residues
in the world



Photo 3.6
Rice husk burning with a clean flame at a residence in Malawi in a gasifier stove from Paul Olivier

Even a good stove does not perform well when it is fed with unsuitable and /or wet fuel. Properly prepared and /or processed fuel is crucial for enhancing efficiency and reducing the emissions of a stove.

Some of the disadvantages associated with bulky residues can be overcome through shaping and compressing the raw fuel, a process called *densification*. Unfavourable burning properties of native residues used in conventional burners can be overcome by the use of micro-gasifier burners that are best equipped to handle this type of fuel.

Micro-gasifiers are best operated with granular fuel that can be poured easily into a fuel container. Thus, a freely flowing, homogeneous fuel with uniform dimensions, such as 6-10 mm diameter pellets, is optimal – though not always feasible to produce. [Table 3.3](#) provides some guidance on feedstock and its potential processing requirements.

The important steps for fuel processing are **drying, sizing and densification**.

Table 3.3 Processing needs of different materials

Size	Examples	Problem	Solution	Processing needs
Particles too small	Sawdust, rice husk	Small particles block gas flow	Produce larger chunks	Densification
Non-homogeneous particle size distribution	Wood shavings mixed with sawdust	Small particles block gas flow	Produce chunks with homogeneous sizes	Densification
Too bulky (high volume, low value)	Groundnut shells, straw, hay	Large combustion chamber needed, transport costs	Needs to be made more compact	Densification
Correctly sized	Anything that can be used directly in the fire chamber: wood shavings, twigs, nut shells, sheep dung, rabbit droppings, corn stovers			(Drying)
Particles too large	Wood chunks, bamboo, coconut shells	Cannot fit into combustion chamber	Produce smaller chunks	Sizing: cutting, chopping, shredding, etc.

Charcoal processing and the potential for gasifiers as mini-charcoal kilns

Inefficient charcoal production is often blamed to be a major cause for forest degradation and deforestation in many African countries. Furthermore, uncontrolled commercial charcoal production predominantly takes place in the vicinity of a market for the sake of keeping transport costs down, often leading to unsustainable use of forest resources. Nonetheless, due to a forest's inherent sustainable production capacity, charcoal production can actually contribute to preserving forests if it is well regulated, controlled and provides economic benefits to the local people. Many pyrolytic gasifiers can be used as domestic-size *mini-kilns* for producing charcoal, often with higher conversion efficiencies than most conventional charcoal kilns. There is still a lot to explore in regards to this potential paradigm shift in the charcoal value chain. Instead of selling charcoal, forest areas could supply uncarbonised, ready-to-use processed wood (chips, small logs, etc.) to current charcoal users in urban areas. Charcoal production could actually take place under the cooking pot in urban areas and the heat created in the process utilised for cooking.

The TChar-concept would be ideal for this context, as it allows for the use of homemade charcoal.

Further reading

- Interesting plants suitable for combating desertification and biomass energy use have been compiled by *Van Cotthem*: <http://desertification.wordpress.com/3-interesting-plant-species>
- Fuel densities by the Biomass Energy Foundation:
<http://www.drtilud.com/wp-content/uploads/2013/11/bef-archive-fuel-densities.pdf>
- *A simple alternative to charcoal* by Lanning & Means (January 2013 at ETHOS)
This presentation explores energy efficiency along the value chain from wood to cooking energy and illustrates the potential for micro-gasifiers to be used as charcoal kilns when using processed wood biomass.
<http://www.vrac.iastate.edu/ethos/files/ethos2013/Room%202/Sunday%20PM/A%20Simple%20Alternative%20to%20Charcoal%20.pdf>
- *Charcoal production from alternative feedstocks* by NL Agency (2013)
This report provides background information for the Alternative Charcoal Tool, including an overview of alternative charcoal production technologies and a description of three supply chains presented as case studies. The case studies cover the feedstocks charcoal dust, cotton stalks and bamboo. The report shows differences and similarities between various feedstocks in detail.
https://energypedia.info/wiki/File:Charcoal_Production_from_Alternative_Feedstocks_-_NL_Agency_2013.pdf
- *Making charcoal production in Sub Sahara Africa sustainable* by NL Agency (2010).
This report assesses the bottlenecks and the possible solutions for making charcoal production in Africa sustainable.
https://energypedia.info/wiki/File:Making_Charcoal_Production_in_SSA_Sustainable_-_NL_Agency_2010.pdf
- *Charcoal production in the Cooking Energy Compendium* by GIZ HERA
This website provides an overview of the basics, limitations and potentials of charcoal use and charcoal processing technologies.
https://energypedia.info/wiki/Charcoal_Production
- *Charcoal in Africa: Importance, Problems and Possible Solution Strategies* by A. Seidel (2008)
https://energypedia.info/images/2/22/Charcoal-in-africa-gtz_2008-eng.pdf

3.2.1 Drying

Drying left to the Sun or the wind are practical and cheap options in most cases requiring the drying of biomass cooking fuel. Subsequent dry storage complements these efforts and prevents the fuel from regaining moisture.

There is a differentiation to be made between the core moisture of a fuel and its surface moisture. Surface moisture (when a core-dry fuel gets wet in a rain shower but the moisture has not yet penetrated into the core) can be removed in a couple of hours, while core-moisture requires days, weeks or even months to be removed (depending on the diameter of the fuel pieces).

Biomass fuel can easily be pre-heated to remove residual moisture when the fuel is kept close to the stove prior to use. Some stoves have special features such as a warming-drawer for fuel underneath the stove for just this purpose. Drying in kilns and ovens is typically not suitable for household fuels, so will not be discussed in this manual.

3.2.2 Sizing

Sizing is understood here as **size reduction** of predominantly woody biomass fuels that are initially in the form of large stems or logs that do not fit into the fuel container of a micro-gasifier. Small chunks of fuel appropriate for a micro-gasifier can be obtained by chopping, cutting, chipping, grinding, breaking, sawing, etc.

The output of a downsizing process generally must be sorted into classes of particle sizes afterwards. This is either done by hand or with sieves or screens in order to separate the *right chunk sizes* from finer ones that can obstruct gas-flow and need to be *up-sized* for fuel use.

Some types of machinery may yield too fine particles for direct use as fuel. They may, however, be useful for achieving the smaller particle sizes needed for most densification processes described in the next paragraph. The preparation of feedstock for *up-sizing* or agglomeration processes to create larger chunks from small or inhomogeneous particle sizes is often more tedious and labour-intensive than actual densification. It is very important to cover these steps prior to scaling-up.

Convenience is the enemy of time and labour-intensive fuel preparation

Sizing-requirements can be a make-or-break factor for the acceptance of micro-gasifiers in a region. Chopping wood by hand requires significant physical effort that most people dislike and complain about. If too much additional effort is required to prepare a fuel, gasifier stoves will not be accepted and successful adoption is less likely.

In areas where the supply of wood in the form of big logs or sticks is still abundant, the down-sizing of fuel into a micro-gasifier-friendly format is probably not a feasible option. In such cases, other stove models such as a rocket stove that can burn stick-wood clean and efficiently might be more accepted and suitable for household cooking. If the production of biochar is a major interest and domestic cooking is not required, larger (barrel-sized) retorts could be considered. In areas without a regular supply of smaller-sized fuels, establishing a fuel-supply chain of down-sized wood (e.g. wood-chips) at reasonable cost and convenience is likely to improve the acceptance of micro-gasifiers for cooking.

An encouraging example can be found in India, where the Champion stove (described in detail in [Chapter 4.2.2](#)) is well accepted in an area with access to prunings from a mango plantation.

PROJECT EXAMPLE: Champion stove in the Sundarbans, India

Within the framework of a joint project aimed at improving livelihoods and conserving mangrove forests in the Sundarbans (West Bengal, India), the company atmosfair and local partners Servals Ltd and Sapient Infotech placed the first 3,000 TLUD Champion stoves in communities at subsidised prices through December 2013. Users have been generally satisfied with the stoves and have gone on to adopt them. A survey conducted in March 2013 revealed that the key benefits of the stoves, according to the users, included fast cooking due to their high fire-power, savings on fuel acquisition, less smoke, and convenience on account of a steady flame. They also liked the continuous cooking option provided by the stove's second fuel container that can easily be exchanged since the pot rests on an independent tripod.

Fuel preparation does not seem to be a problem being that the stove can use a wide range of available materials like coconut shells, carpentry waste, etc. A popular fuel source are the prunings from mango plantations. This fuel is extremely popular since it is very energy dense and yields high-grade charcoal in the gasifier. This charcoal fetches good prices on the market and has triggered a buy-back scheme for charcoal as a fuel. The implementation status report from October 2013 by atmosfair highlights the potential for income generation using the stove as a mini-charcoal kiln that provides cooking options: *Charcoal buy-back from stove users was started in June/July 2013, and it was seen that each user is generating around 20-25 kg of charcoal each month. The participating users get a buyback at 8 INR per kg of charcoal resulting in a payback of 160-200 INR per month. A charcoal collection chain has been set up under subsidy from atmosfair which employs local youths for collection of charcoal from users in a bi-monthly frequency. The charcoal buy-back chain also provides indirect employment to transport providers and drivers. The collected charcoal is used by industrial users and restaurants that are replacing conventional charcoal. The replacement of conventional charcoal allows for additional emission reductions.*

Find the full status report and other documents about the project's activities at: <https://www.atmosfair.de/en/projekte1/projekte00/india-efficient-wood-gas-stoves>

Photo 3.7
People like the clean and steady flame without the need to keep feeding small cuttings into the fire (M. Tobiassen)





Photo 3.8
Mango prunings:
very hard and
energy dense wood
(M. Tobiasen)

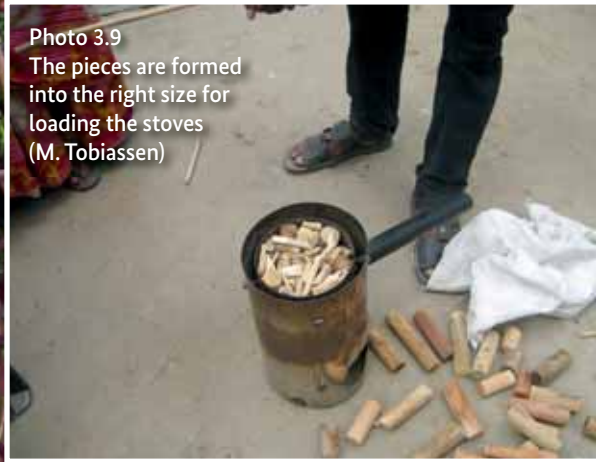

Photo 3.9
The pieces are formed
into the right size for
loading the stoves
(M. Tobiasen)



Photo 3.10
Charcoal from a
Champion stove
on sale
(M. Banerjee)

Downsizing equipment

The input material for a briquette or pellet machine must be smaller than the densified output product. In other words, to produce a pellet of 6 mm in diameter, the feedstock needs to be 6 mm in diameter or smaller. Industrial equipment is based on shredders, grinders, or hammer mill-type choppers; while cutting mills/shredders cut the material with rotating cutting *teeth* made of hard metal, hammer mills mainly use impact forces to transform feedstock into very small particles. The screen stipulates final particle size, and the final product is more akin to flour. Hammer-mills are more suitable for granular or leafy input material as straw and grass. They can often be manufactured locally, as a typical maize mill will usually be based on the same design.

Equipment of many sizes exists and has to be selected according to the specific needs of a location and the scale of operation. Nevertheless, the suitability of the equipment depends greatly on the properties of the input material. The requirements for electrical energy input also vary greatly. *Figure 3.5* shows that pellet production (requiring first downsizing then agglomeration) is a great deal more power intensive than chipping or chopping.

Figure 3.5 Mechanical energy needed by machinery type to process 1 tonne of material

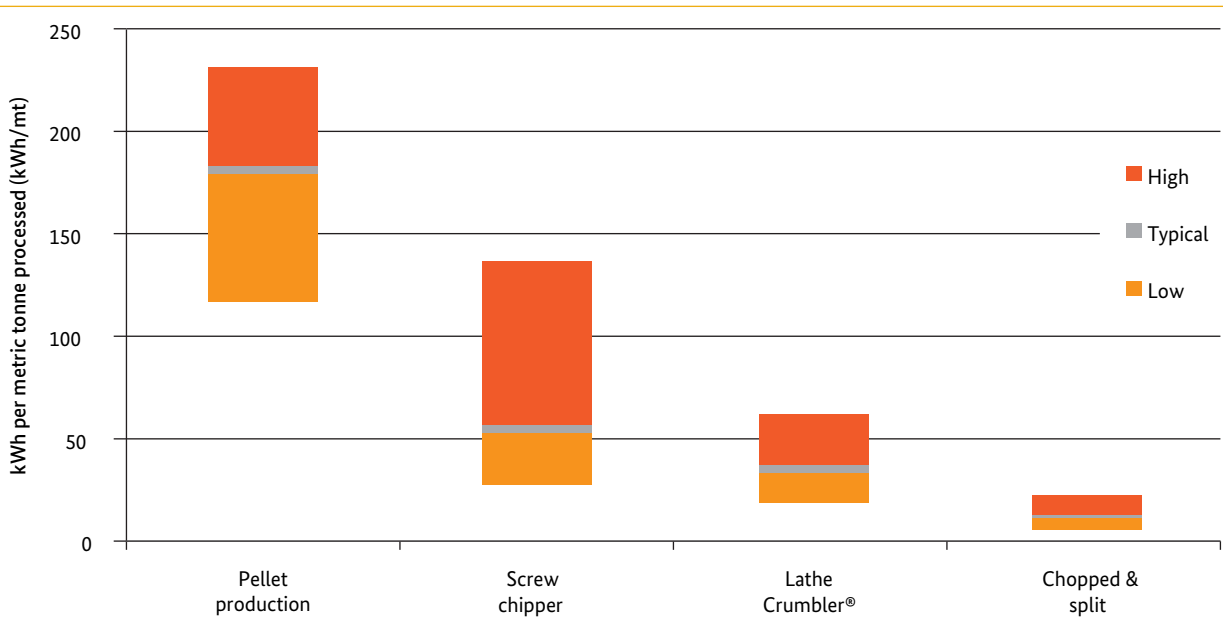

Source: Means and Lannings (2013)

It is important to remember that for any densification business, the pre-processing down-sizing machinery has to have the same throughput as the densification machinery to avoid bottlenecks, endangering the viability of the business. In other words, if a briquette machine has a throughput of 200 kg/hour, the pre-processing grinder has to deliver at least 200 kg/hour, or the briquette machine will not be able to run on full capacity. Operations based on human power to drive sizing equipment might be feasible on a limited scale. For larger operations it is advisable to use external power sources. The downside of this is that it might not be economically viable for some, especially in

areas without an affordable or reliable electricity supply. Large equipment is expensive and requires capital input exceeding the levels of affordability for community-based initiatives. Not many examples are known of economically viable supply chains for gasifier-ready fuels. Hopefully, the next version of this manual will have promising examples and lessons learnt from developing countries.

Sizing equipment for manual operation

The main tools for manual sizing operations are shears, knives, axes and splitters; these are suitable for creating chunks and splinters, but not for making powdery material. Saws, chippers and grinders tend to produce finer particles that must be screened out before use in a gasifier stove. Some chippers have fly-wheels that drive rotating blades and grinders for mechanical operation. Although perhaps strenuous by hand, low-cost, manually driven machinery may also be good options, especially if employment creation and decentralised preparation of feedstock are desired.

The following links provide some examples from Engineers without Borders (EWB) to cut straw, grass and other leafy materials without motors or electricity: <http://www.youtube.com/watch?v=ZrtMnbgNFdE> A manual chopper developed by Leland Hite is shown at: <http://www.youtube.com/watch?v=fAZ3myOEFew>; plans for download can be found at: http://www.home.fuse.net/engineering/biomass/Easy_BioChop.pdf

Leland Hite has also developed a low-cost solution for manual grinding of a variety of soft, dry biomass. The **grinder** is easy to build primarily using hand tools, is easy to operate, easy to maintain and requires no welding. The grinding head is made of concrete and is easily rotated using a hand-crank. It does not have a sieve for adjusting particle sizes. The unit can be powered with a bicycle, a foot powered treadle, a gasoline motor or an electric motor. Grinding pressure is easily adjusted via the weight of a few rocks in a pail. Watch a demonstration at: <http://www.youtube.com/watch?v=5solgSYXeJ0> or download building plans at: http://www.home.fuse.net/engineering/biomass/Easy_BioGrind.pdf

Figure 3.6 The Easy-BioGrind by Leland Hite



Source: Easy_BioGrind.pdf
(Hite and Smith (2011))

The hand-operated Thresher Masher Chopper TMC-1™ was developed by the Legacy Foundation to chop and grind materials for biomass briquette production. It was designed to be manufactured with local resources. While it requires resourceful metal workers, it can be fabricated with ordinary files, spanners and other common hand tools and clamps along with an ordinary hand-held electric drill, a small disk grinder and a small portable electric (stick) welder. The unit is an all-steel welded construction that utilises sealed-pillow block bearings to sustain the moving part for durable and efficient operation. The plans can be purchased at: <http://www.legacyfound.org/store/home.php>

Motor-driven equipment

The most common equipment for large-scale operations are driven by motors. The equipment can differ in terms of power requirements, capital costs, running cost and output per hour. There are also differences in wear and tear and maintenance requirements; the blades and teeth, for example, need constant sharpening.

Tools with blades and teeth

- **Shears** use two wedged blades moving against each other to cut through twigs and branches.
- **Saws** have a moving blade with teeth. They are ideal for cutting wood against the grain. Saws can differ by their:
 - type of power (mechanical, hydraulic)
 - source of power (external motor or a gen-set, grid power)
 - transmission (through the shaft of the tractor)
 - type of blade (fixed blade, chain saw, rotating blades, band-saw)
 - direction of blades or tables movements (horizontal, vertical).
- **Splitters** have wedged blades and are ideal for splitting with the grain (lengthwise).
- **Chippers** have a chipping tool that works with impact to cut wood and branches against the grain. Chippers differ by their:
 - type of tool (rotary blade, blade fixed on a drum, auger)
 - power transmission (tractor shaft, own engine, electrical power)
 - type of feeder for material intake (chain-link conveyor, rotating shaft).
- Choppers and chippers can deal with medium-sized branches and logs, but they often become blocked by fine twigs or inhomogeneous input materials. **Screw auger chippers** are reported to require less maintenance and to be relatively efficient. They can transform a wide range of material sizes and moisture contents into wood-chips that are mostly free of small fines, ideal for use as a micro-gasifier fuel.
- **Lathes** use horizontal knives to *peel* thin layers of wood off of straight logs. The sheets can be processed into smaller homogenous pieces mostly free from fines.
- **Grinders** scrape off small particles from the wood with their metal teeth and create rather inhomogeneous material.
- **Single-shaft shredders** combine hard *knives* fixed on a rotating shaft and a large piston that pushes the material to grind with hydraulic power against the shaft. An automatic reverse gear ensures that the machine can handle different feedstock sizes ranging from small twigs to entire logs or wooden pallets without getting blocked. A large hopper and feed opening makes this very suitable also for light-weight, twiggy feedstock like cotton stalks. The hydraulic system and the slow rotor speeds enable this type of machine to operate with relatively low power requirements – depending on desired throughput, feedstock material properties and the desired maximum output particle size, which can be determined by the size of the screen.

Figure 3.7 Single-shaft shredder

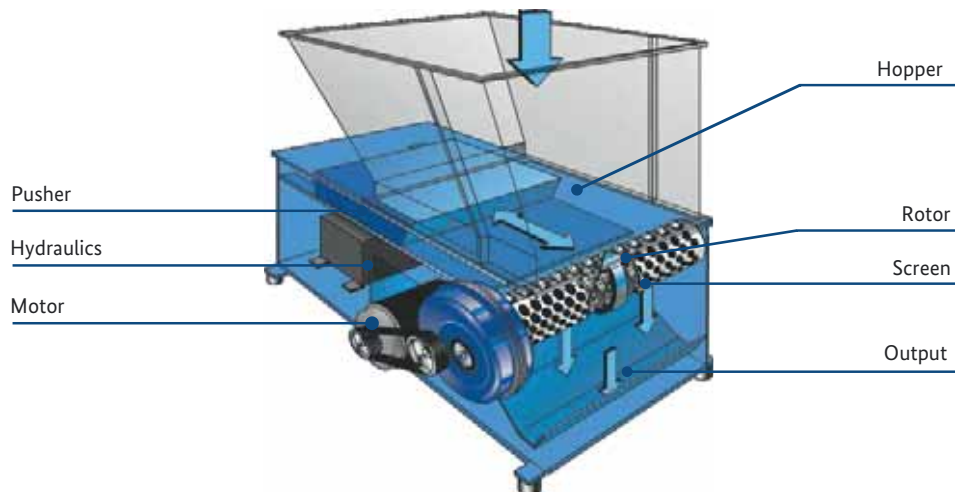

Source: adapted from Gross (2004)

For a briquette production from cotton stalks in Uzbekistan, a single-shaft shredder was recently identified as the best option for pre-processing the stalks into small pieces of 12 mm. Cotton stalks are normally difficult to cut due to extremely varying material properties: they are partially woody with hard root-knobs (too hard for hammer mills or blades) and spongy cores (too elastic to cut with rotating blades). The shredder had no problems with the stalks (*see photos below*). Subsequent transformation into a briquette is shown in the paragraph about piston presses.



Photo 3.11
Rotating shaft with knives at the bottom of the hopper



Photo 3.12
Cotton stalks in the hopper



Photo 3.13
Ground material exiting through the 12 mm screen

More research and the sharing of information on appropriate size-reduction technologies with low power consumption for producing fuels for micro-gasifiers (with uniform particle size distribution and less fine particles) are needed in the future.

Further reading

- TFZ in Germany compiled a list with suppliers of saws and splitters at: http://www.tfz.bayern.de/mam/cms08/festbrennstoffe/dateien/scheitholzaufbereitung_saegen_spalter_bauarten.pdf
More information can be found at (in German):
http://www.tfz.bayern.de/mam/cms08/festbrennstoffe/dateien/mobile_hacker_bauarten.pdf
- An index of available wood-sizing machines relevant for preparing gasifier fuels, such as chippers (disk and drum), saws, shears, splitters, and rotary blade choppers, etc., has been compiled by ALL Power Labs:
<http://wiki.gekgasifier.com/w/page/6123688/Chippers,-chunkers,-loppers,-splitters,-shredders,-disintegrators,-etc>

3.2.3 Densification

The most vital type of processing is the densification of bulky low-grade biomass materials that are available in high volumes in the form of waste; without processing, they are not suitable as cooking fuel. Here, larger and uniform chunks need to be created from small particles.

Compacted and densified fuel has several advantages:

- higher heating value per volume (more carbon per volume)
- reduced transport costs (more fuel, less volume to be transported)
- more predictable performance in a stove due to more uniformity in size, shape, density, etc.
- easier and cleaner to handle (less dust, easier packing, etc.)
- increased convenience since the fuel already comes in the right size and is ready-to-use (no chopping required)
- better storability (less moisture absorption, less mould, less spontaneous fire outbreaks through self-ignition, fewer insect infestations, less storage space required than natural fuel)
- can provide a solution for waste management problems
- adds value to low-value residues, often creating employment in the process.

However, densified biomass is not a magic bullet! It requires suitable technical equipment, a feasible market (supply and demand) as well as investment in equipment and skilled labour. Minimum requirements for the set-up of densification facilities and marketing are:

- fuel is already a commodity (like in many urban areas)
- households have purchasing power to buy processed fuels
- there is a large source of unused, *wasted* residual biomass at low or no cost

- usage as fuel does not compete with the use as manure or compost
- there is a possible link between the source of biomass and the market for densified fuel (in relation to distance, transport costs and the value of the fuel)
- fuel densification can be run as a viable income-generating business
- electricity is available so that larger scale operations can be done; without electricity, only manual production on a small scale is possible.

How can materials be densified for use in micro-gasifiers?

Various binding and compaction methods are used to *glue* the loose biomass materials together to form a compact and dense shape that does not immediately fall apart during drying, handling or use as a fuel. The intended use for the product and the envisaged scale of operation will determine size, shape and the needed degree of compaction for the product.

The processes of biomass densification can be clustered into three main groups:

1) The wet, ambient temperature, low pressure (10-15 bar) process:

An added binder is optional; binding is carried out through the random rearrangement of softened and detached natural fibres. It can be done with a wide variety of agricultural residues and other granular waste feedstock e.g. sawdust, rice husk, bagasse, coffee/peanut shells. Additionally charcoal dust and crumbs – or purposefully charred agricultural residues – can be added as part of the matrix as long as the fibres are able to encapsulate the fuel material into a tight, non-elastic mass when compressed. Emphasis is on the careful blending and pre-preparation of feedstock for pliability, combustibility and other characteristics. Once the principles have been mastered, a far greater variety of ingredients compared to other processes can be used. Densification and shaping can be carried out using one's hand to squeeze the material into shape, or simply human force to press the material into a mould. Over 25 designs for hand-operated or mechanised versions of presses are in use, based on various methods for creating pressure: levers, hydraulic jacks, screw platens, treadle / peddles, etc. Equipment can typically be purchased in the range of 50 to 750 USD. The achievable fuel density is normally low, ranging from 0.3 to 0.5 kg/l.

2) The moist-dry, ambient temperature, low-medium pressure (10-50 bars) process:

The next level would usually start at a similar pressure as the previous process, but can progress far beyond this point depending on the type of machinery used. The process involves some form of binder (clay, starch, banana peel paste, waxes, glues, molasses, etc.) with temperatures still near ambient but with water being either minimal or absent. The relatively dry feedstock mix allows for the use of loose augurs (*screws*), rams or pillow compression cylinders and the above-mentioned *wet process* presses. Over 10 designs for hand-driven or mechanised presses using various augurs and rams are in use. Investment costs for equipment can start at 50 USD for hand-driven devices. Achievable fuel density ranges from 0.3 to 0.7 kg/l. The product range includes waxed logs and briquettes from char dust, which are finding increased acceptance in developing countries.

3) Dry, high-pressure process:

The next kind of densification involves a great jump in pressure (400 to 600 bars), and requires drying equipment to assure a moisture content in the feedstock of below 20%. Compression by a ram or auger often requires added heating jackets which raise the barrel/cylinder/die temperatures up to around 200° C. This combination of pressure and temperature effectively scorches the exterior wall of the resulting log, and it tends to melt the lignin of the biomass to accomplish binding. The process requires an assured supply of feedstock of a known type, grade and moisture content. Investment costs for these industrialised machines start at 3,000 USD, with hardly any upper limit.

Various briquette and pellet presses are available for the industrialised world. Fuel densities can even go beyond 1.0 gm/cc (the density of water), as some highly densified briquettes and pellets are heavier than water and thus do not float (an easy test to determine fuel density). There is the risk that dense but super dry pellets and briquettes may crumble in more humid conditions when they regain moisture. Generally, product quality increases with rising compaction pressure, which entails:

- Higher temperatures: Causing the lignin contained in the feedstock itself to *melt*, acting like wax as the sole binder; additional binders may be unnecessary.
- Less water needed for the feedstock preparation: Thus, less drying time and space are needed afterwards; lower moisture content of the product lead to higher heating values.
- Rising electricity requirements (can be well in excess of 100 kW for large equipment).
- Higher costs for investment and operation: capital investment for machinery with able to produce more than 1 tonne of fuel grade pellets per hour typically exceeds 100,000 EUR.
- Decreasing labour intensity which reduces job creation in the production phase, with the potential for more local job creation on the fuel distribution chain.

The difference between briquettes and pellets

The term *briquette* is commonly used for a sizeable *chunk* of densified product of any shape and compaction level where the smallest side-length is above 25 mm in size. Briquettes are normally pressed *into a mould* that grants the briquette its final shape.

The term *pellet* is used for short, roundish sticks of 6-25 mm in diameter as a product of a high-pressure agglomeration process. Pellets are shaped by pressing dry biomass at very high pressure through a die with many round holes (like an oversized spaghetti maker).

It is not easy to determine the best choice of biomass densification in a given environment as many factors influence feasibility.

Figure 3.8 attempts to provide guidance for the choice of densification options according to the desired pressure and intended throughput per hour. It reflects methods of feedstock preparation and compaction, binders, etc.

The availability of required inputs like water, electricity, capital, labour, space, and the like is critical for the success of any densification project. These can potentially be limiting factors for the feasibility of a densification option and should initially be used as part of the *make-or-break* arguments. Please note that the factors described find themselves in a continuum and do not have clearly defined, concrete values that set clear-cut boundaries from one category to the next.

Figure 3.8 Guidance tool for identifying appropriate biomass densification options

Pressure and build-up of temperature	low	moderate	high	very high
Preparation process	water slurry (solid in water)	wet / moist (water in solid)		dry < 20% moisture
Binder	natural fibres rearranged	needs binder: clay, wax, starch, molasses,		melted lignin from biomass
Shaping process	hand moulded	pressed into a mould	extrusion through a die	
Means to build-up pressure	hand	light severs, screws	strong severs, screws	screws, pistons rollers and dies flat or round
Electricity input needed	none	optional	single phase < 5 KW	triphase 5-100 KW > 100 KW
Labour intensity	high	moderat		low
Scale of business (output in kg per hour)		low	< 50 kg per hour	> 1000 kg per hour
Capital investment		> 100 EUR	> 1,000 EUR	> 10,000 EUR > 100,000 EUR
Business premises		drying space		storage space, electricity

Source: Christa Roth (2013)

Low-pressure moulding by hand or low-cost light levers require a wet preparation of feedstock in addition to drying space after production. It might yield enough output for single household consumption or a family business. Economies-of-scale with outputs of densified product above 1,000 kg/h require capital-intensive machinery and a tri-phase electricity supply well above 20 KW, which might be limiting factors in certain locations. Some examples of options are presented in the following paragraphs.

I) Manual briquetting options (wet pulp, low pressure)

a) Hand-shaped briquettes

Hand-shaped briquettes are the simplest way to make small briquettes. A slurry of biomass in water is left soaking for some days to enhance its binding properties. The pulp is either squeezed by hand or pressed into a mould, e.g. an ice-cube tray. Rearranged fibres, assisted by a binder such as paper pulp keep the briquette in shape during drying and use. Squeezing briquettes by hand or an extended period of time can be rather labour intensive and very tiresome as well! This method is good for making briquettes for one's own household or neighbourhood but is not suitable for a commercial operation.



Photo 3.14
Hand-squeezed
briquettes (FoST)

b) Briquette shaped with a simple mould from a perforated bottle

Another simple manual method for small-scale production is promoted by the Foundation for Sustainable Technologies (FoST) in Nepal: the wet biomass slurry is fed into a perforated bottle, interlaid with some discarded CDs to separate small *pucks*. Pressure is exerted with a stick from the open end of the bottle and the water squeezed out through the holes of the bottle. FoST also promotes large lever-presses (<http://www.fost-nepal.org>).



Photo 3.15
Bottle press shown by
Mr Sanu Kaji Shrestha
from FoST in Nepal



Photo 3.16
Various shapes and
sizes of briquettes
for sale in Nepal

II) Lever-presses (wet pulp, low-moderate pressure)

Lever presses are good tools for creating heightened pressure utilising only the input of human power. Long or multi-compound levers increase the achievable pressures. Lever presses are faster to use than screw platens or hydraulic jacks. There is a large number of different lever presses available on the market. This section showcases only a selected sample of models which are easy to replicate or for which replication plans exist.



a) Paper brick press, by Newdawnengineering, 30 EUR.

Makes a 230x 90 mm fuel brick out of waste paper which can be mixed with other combustible fuels such as wood chips, grass or coal dust. Paper is a very good binder and should be used in combination with any other waste fuels that are available. Pressure is generated by two small levers.

Ideal for decentralised, small-scale production. More details at:

<http://www.newdawnengineering.com/website/paper/brick>

Photo 3.17

Pressed paper brick (Newdawn)

Photo 3.18

Simple paper-brick press (Newdawn)

b) Low-cost presses *Easy BioMold - Your choice*, by EWB

Leland Hite, Dr Zan Smith and Ron Gorley from the Greater Cincinnati Professional Chapter of Engineers without Borders (USA) have compiled a very useful and comprehensive guide to simple and low-cost biomass fuel briquette presses from all sorts of materials and makes at:

http://home.fuse.net/engineering/biomass/Easy_BioMold_Your_Choice.pdf

The page has drawings and assembly instructions for a selection of moulds to make round, square, stick, cube or chunk briquettes suitable for micro-gasifier stoves.

Figure 3.9 Various options for lever presses



Source: Easy_BioMold_Your_Choice.pdf (Hite, Smith and Gorley (2012))

The introduction to their text states: *This document is about ‘Choices’. Briquetting for any operation requires a biomass mould of one type or another, whether it’s for a small village, single family, or classroom operation. You have ‘choices’ and there is no universally wrong or right, best or worst, good or bad moulds for making biomass briquettes. A variety of moulds can work equally well and one type may be best suited depending on the availability of construction materials and tools, cost, skill level, and briquetting requirements. This document provides choices to consider when selecting a biomass mould design.*

The *Stick & Cube Briquette Mould* described on page 17 as a do-it-yourself solution is the most interesting for micro-gasifier fuel preparation. The *stick* measures 25 x 38 mm with a length of 225 mm. It can easily be broken into chunks of 25 mm in length, ideal for gasifier cookstoves.

Consult: http://www.home.fuse.net/engineering/ewb_project.htm for further biomass designs, fuel briquette moulds, briquette presses, choppers, grinders, composters, etc., including a parts list, notes and drawings. There are also links to very instructional videos as well as instructions on how to make fuel briquettes with a press.

Find additional biomass briquette formulations from around the world at: http://www.home.fuse.net/engineering/biomass/Biomass_Fuel_Briquette_Formulations.pdf

Read more about *Rice husk briquettes for use as fuel* using various binders at: <http://www.home.fuse.net/engineering/biomass/DEVELOPMENT%20OF%20RICE%20HUSK%20BRIQUETTES%20FOR%20USE%20AS%20FUEL.pdf>

There is also an online fuel briquette network – a great resource for sharing information, further support and / or broadcasting your own work: fuelbriquetting@googlegroups.com

c) Wooden presses by Richard Stanley and the Legacy Foundation

Richard Stanley and the Legacy Foundation are among the most active promoters of manual biomass briquetting across the world. The website (<http://www.legacyfound.org>) has comprehensive resources on manual briquette-making and numerous publications for sale. There are various versions of the common ram-type press, cheaper ones made of wood, and stronger lever-presses that can also be made of more durable metals at a higher cost.

d) Metal presses by Legacy Foundation

The metal ratchet press was developed by Rok Oblak and Richard Stanley. The principle is similar to that of heavy-duty ratchet hi-lifts. Construction and user manuals can be purchased on the online store (<http://www.legacyfound.org/store/home.php>). The construction manual for a portable Porta Press™ can also be found on this site.

Photo 3.19 show the ratchet press and *Photo 3.20* some briquettes made in various shapes, some by the press and some by hand, in Malawi. The mixtures vary according to the available materials.



Photo 3.19
Ratchet press
used in Malawi

Photo 3.20
Various briquettes
in Malawi



e) Multi-sausage adapter for batch-fed presses by Richard Stanley

In response to the search for methods for making smaller diameter sausages for their TLUDs and other gasifiers requiring more consistent and smaller diameter fuels, Richard Stanley posted the following drawings for manually operated pellet moulds on the bioenergylist in October 2013. He added the request to *use it, play it forward, ... but share your experience in the process.*

Figure 3.10 Cylinder for multi-sausage pellet production with a manual lever press

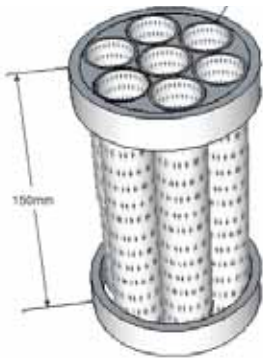
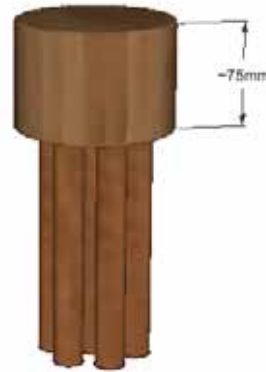

Figure 3.11 Piston for a manual pellet mould



Source: adapted from R. Stanley (2013)

III) Briquetting options: medium-high pressure, moist-dry feedstock

This category comprises of cubing systems and presses that can either be mechanically powered e.g. by a large fly-wheel or electrically powered with electricity requirements dependent on the pressure and intended throughput. The rate of densification or achievable throughput per hour, the energy consumption of the press, and the quality of the briquettes produced depend largely on the properties of the feed material (flow ability, cohesion, particle size, distribution, etc.). The moving parts that generate the pressure against a die are either rotating screws or pistons.

Typically, hourly outputs are limited by the diameter of the die. Operation times depend on temperature build-up, with stopping required before the machine overheats.



Photo 3.21
Cubing system or hay-cuber (Y. Huangfu)

a) Cubing systems

Cubing systems are lesser-known machines that make small cubes out of straw, switchgrass, miscanthus, corn stover or other biomass. They seem popular in China where national policy supports the use of agricultural residues to replace or complement coal. A photo by Yibo Huangfu from the 2013 Stove Expo near Beijing shows a cubing system, similar to the machinery that can be found in the USA at: <http://www.warrenbaerg.com/index.php?n=51&id=56&topic=Biomass+Cubing+%26+Grinding+Operaton+for+Baled+Biomass>

b) Screw-type extruder presses

In an extruder or screw press, a rotating, conical screw takes the biomass feedstock from the hopper and extrudes it through a round or hexagonal die. The friction between the material and the die causes the material to heat to 300° C at which point the lignin is mobilised as a binder. A heating mantle around the die is common feature for inducing the *toasting* of the surface of the briquette, making dark and shiny like wax. For this reason, this type of briquette is also called *waxed log*. It is becoming increasingly popular in urban areas around Asia, especially Bangladesh.

A *hollow-core* briquette exits from the front in a continuous stream and gets broken off to the correct length. The hole in the centre of the briquette originates from the extruding screw. This screw is subject to wear-and-tear with its material quality greatly influencing its life-span. In developing countries, extruders can often be manufactured by skilled artisans. The capacity of screw presses usually ranges from 75-250 kg/h. Due to the high friction, mechanical wear on the screw press is high and energy consumption can be considerably greater than for hydraulic or mechanical presses.

Figure 3.12 The principle of a screw-type extruder press

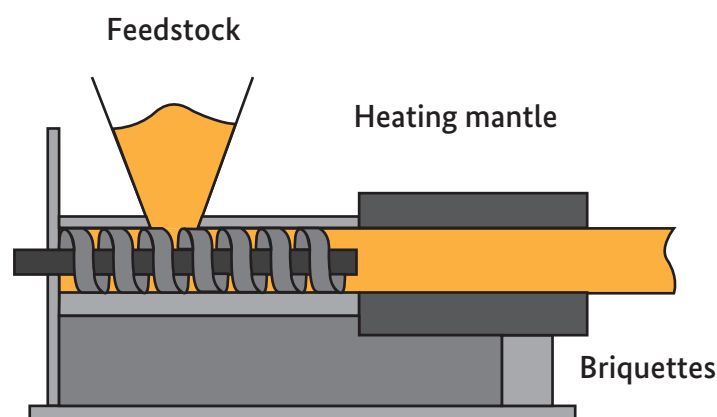

Hollow-core briquettes have been used in micro-gasifiers but there are no known test results for performance or emissions. They are expected to perform slightly better than compact briquettes produced by piston presses described in the next section. More testing is needed in order to evaluate the behaviour of these fuels inside of micro-gasifiers.

Photo 3.22
Waxed-log briquettes
being sold by bicycle
in Dacca
(R. Heine)

c) Piston presses

In piston presses, a vertical screw transports the feedstock from the hopper into a feed-zone in front of the die. A horizontally moving piston punches the feed material from the feed-zone into a die using very high pressure (*die-and-punch*). The briquette is solid (no centre hole) and naturally breaks off at a less-dense layer between two blocks created with each impact of the piston. The product resembles *pucks* or flat disks. Piston presses tend to experience less wear-and-tear than the screw-presses. There are mechanical ram-type versions, powered by a massive fly-wheel, and hydraulically operated ones. Hydraulically operated presses are very heavy as hydraulic oil adds greatly to the weight. In tropical climates, added oil-coolers might be necessary to prevent overheating of the machine, which also limits their operating time since they need to cool off every couple of hours.

Figure 3.13 The principle of a piston press

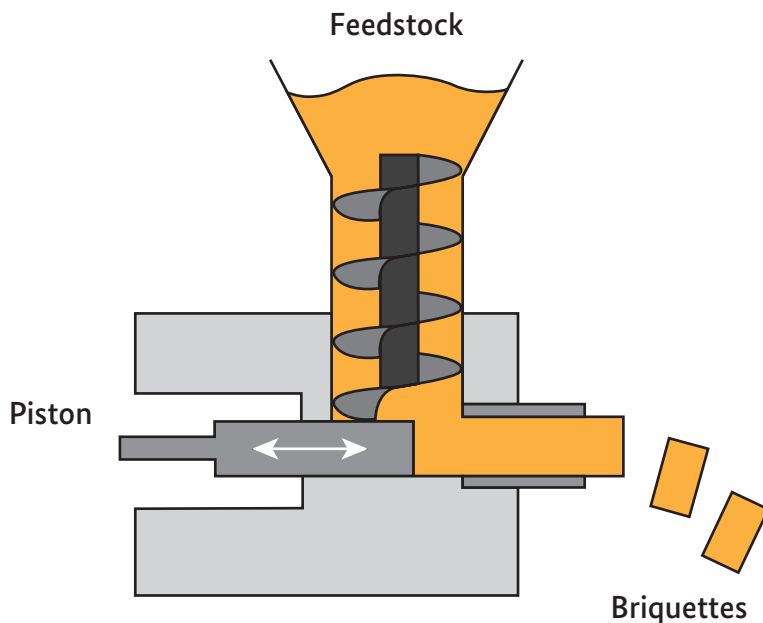

Photo 3.23
Briquette-making
from saw-dust with
a hydraulic press in
Karamoja (Uganda)
(C. Messinger)



Suppliers of industrial-scale briquette presses should be selected according to the availability of after-sales services. According to inquiries by the author from manufacturers at the *LIGNA 2013* trade fair in Hannover (Germany), prices for hydraulic presses start at around 15,000 EUR, mechanical presses at 50,000 EUR.



Photo 3.24
8 briquettes of 50 mm diameter from cotton stalks = 1 kg

Further reading

- A list of suppliers of various machines compiled by TFZ (in German):
http://www.tfz.bayern.de/mam/cms08/festbrennstoffe/dateien/pelletier_briketiertechnologie.pdf
- Selection of links to suppliers based on visits by the author:
 - Ruf (Germany) <http://www.ruf-brikett.de/home.php>
 - Gross (Germany) <http://www.gross-zerkleinerer.de/english/default-english.htm>
 - Mütek (Germany) <http://www.hartmut-mueller-gmbh.de/en>
 - Reinbold (Germany) <http://www.reinbold.de/english/default-english.asp>
 - CF Nielsen (Denmark) <http://www.cfnielsen.com>
 - Pawert (Switzerland) SPM <http://www.pawert-spm.ch/en/index.htm>
 - DiPIu (Italy) <http://www.di-piu.com/index.html>

IV) Pelletising Options

The principle of a pellet mill is derived from old oil mills where heavy rollers would roll across the feedstock material to press oil out, leaving behind a press cake. In a pellet mill (also called press) all feed material is pressed through the holes of a hardened steel die at high pressure by a roller. One of the parts moves while the *counterpart* remains stationary. The feedstock must be dry (< 16% moisture content) and finely ground into sizes smaller than the final diameter of the pellet. Extremely high pressure causes

high friction and high temperatures as the feedstock is forced through the small holes of the die. The lignin in the biomass may partially melt and act as a binder, so that no additional binder is needed. Pellets are formed into a continuous *spaghetti* which is cut into length by a blade. The pellets exit the machine at high temperatures and often need to be cooled before packing. The achievable throughput per hour depends on the fuel properties as well as the size and the total square area of the holes in the die. Common pellet diameters are either 6 mm (standard size of wood pellets for automated space heaters in Europe) or 8 mm. Some *maxi-pellets* with a diameter of 20 mm are currently being tested in Germany for use in micro-gasifiers.

The power (electricity) requirement is generally high and increases with the hourly output of the machine as well as the hardness of the feedstock. Woody materials have less output per hour than softer materials and thus require more electricity per kg of pellets produced.

Pellet mills necessitate continuous feeding of the pre-processed and conditioned feedstock. If they run dry, major damage may be done to the rollers and the dies. The volume reduction of the feedstock material is considerable, typically from a starting bulk density of 100 kg / cbm to a final bulk density of 650 kg / cbm. This means that the holding capacity of the pressing chamber in the machine must be large enough to accommodate enough low density feedstock.

Briquetting or pelletising?

There is no right or wrong answer to this question as there is a lack of known examples available to make a reliable comparison. For now, it all depends on local conditions: the feedstocks, the amount, reliability and cost of the power supply, investment capital, intended scale, etc.

Low-density briquetting can be done *by hand* without external power sources and on a small scale. Medium-high density briquetting tends to have lower requirements for investment, maintenance and running costs but also lower throughputs per hour, especially for briquettes with small diameters of 30-40 mm that are suitable for micro-gasifiers. Piston presses can run with very little supervision and currently seem to provide the best relation of power input, material throughput, supervision needs and wear and tear.

High-density pellets can only be produced with considerable power input, easily exceeding 50 kW, which is often not available in the grid in developing countries. Pellet mills have higher throughputs but also more wear and tear. Thus, greater requirements for maintenance and costly replacement parts like the rollers and dies ensue. A pellet mill requires constant attention during operation as well as skilled and experienced operators.

The main types of pelletisers are differentiated by the die, either flat or ring-shaped.

a) Flat-die presses

In flat-die presses, the die is a flat disk of hard steel alloy with a dense array of round holes. The die is normally placed horizontally in the machine allowing feedstock to fall on it with gravity while pellets fall off underneath. The rollers are fixed on a vertical shaft. There are two types of flat die presses: either the die rotates and the rollers remain stationary or the die is fixed to the body of the machine and the rollers move (see [Figure 3.14](#)):

The roller heads (A) are mounted to a horizontal bearing (B) which is fixed to the vertical axle (D) that is turned by the drive shaft below (E). The small gap between the rollers and the die (C) can be adjusted according to the feedstock so that the rollers do not touch the die but roll over a *carpet* of the feedstock for pelletisation. The roller heads are not driven by a power source but rather by the friction of the feedstock layer. The drive shaft rotates at low speeds and the rollers continuously roll over the layer of feedstock on the die (usually at less than 3 m/sec), grinding it down further while slowly pressing it downward through the die-holes. To create more grip, pressure and torque, the roller heads are produced with grooves or dimples, depending on the feedstock properties. Rollers can also be slightly conical to reduce the shearing forces on the material when rolling over a die with a small radius.

Figure 3.14 Construction principle of a flat-die pellet press with rotating rollers

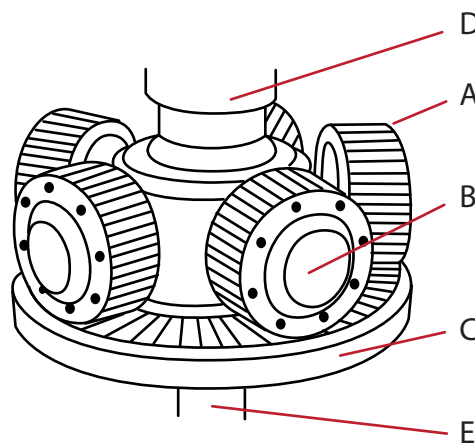

High pressure of up to 600 bar along with enormous friction cause temperatures on the die to rise well above 100° C. High temperatures increase flowability of the feedstock but pellets need to be cooled after exiting. Thicker dies and longer press channels create higher compaction and harder pellets. As the die is flat, its diameter and the surface areas of the die holes are the prevalent factors determining the material throughput, apart from the hardness of the feedstock.

Photo 3.25
A flat die and rollers
with radial grooves



Photo 3.26
Producing pellets
from waste biomass
and supplying gasify-
ing cooking stoves
(ECS Zambia)



Making good pellets is not easy. Experience by Emerging Cooking Solutions (ECS)

ECS is a Swedish-Zambian Joint Venture, working in Zambia on producing pellets from waste biomass and supplying gasifying cooking stoves since 2010. ECS currently has 22 full-time employees and one pellet factory in Zambia, with a production capacity of 3,000 tonnes per year, which translates to a fuel supply for 10,000 households. The brand and make of the pellet mill is titled Sweden Power Chippers 300 Twin (see [Photo 3.26](#)). The capacity is around 500-550 kg / hr depending on the type of biomass.

ECS's concept is to provide high-quality gasifying stoves at or below purchase price, creating a market for its fuel pellets. These are sold at economically viable margins, yet are cheaper than charcoal or LPG. The pellets are branded as *SupaMoto(r)*, which can be translated as *GreatPower* or *SuperFire* and carry the same meaning in several African languages. In Zambia, sawdust from commercial plantations is used in combination with peanut shells and other crop-residues. SupaMoto is also made out of maize-stover and cobs, rice and wheathusks, sugarbagasse and elephant-grass. SupaMoto will always be made out of material that otherwise would go to waste or be burnt in the open, meaning that it will always be 100% renewable.

ECS was experimenting with payroll deduction schemes and other innovative financing mechanisms in 2013 in order to make high-quality stoves available to a greater number of people.

ECS is stove neutral, currently offering the Philips stove as well as an Indian-made institutional stove. However, ECS is also looking into including lower-cost, gasifying household cookstoves in 2014 with the intention of reaching further down in the low-income bracket.

ECS is planning to expand to Kenya in 2014 and expects to continue to be a market-leader in Africa for pelletised biomass cooking fuel.

Contact info:

info@emerging.se, +46 73 502 31 57

www.emerging.se or at www.givecooking.com

Photo 3.27
A Zambian user of the
Philips Stove provided
by ECS
(ECS)



Report on pelletising in Niger by Stefano Bechis

As mentioned in the description of the Aaron stove in [Chapter 4.2.9](#), the commercialisation of this stove in Niger has been delayed due to insufficient production capacity to sustain a regular supply of pellets for a larger number of stoves. The bottleneck is the low output of the pellet press: it has been much less than expected and the material of the machine is not strong enough. Even though parts can be repaired locally, this equates to extra downtime for the machine and increased expenditures.

Feedstock – like millet stalks or any other useful biomass – is processed in two steps: first the material is passed through a Beccaria *Invincibile* hammer mill, a trusted and very simple machine that is manufactured in Italy since decades. It works with a tractor power-take-off (PTO) or with an engine that makes it run at 540 rpm. This hammer mill has proven largely sufficient for the project needs.

Next, fine material goes into two pellet machines JGE 200, acquired from the Czech company GreenEnergy (<http://www.briketovacilis.eu/introduction>) who purchases the machines from China, switches out some internal parts, and then resells them. Each machine is powered by a 15-horsepower diesel engine. The expected output stated by the company was at least 100 kg/h, which is based on softer materials for animal feed. Unfortunately, feedstock to make pellets for energy purposes has to be denser and then the output rate drops. We never achieved more than 60 kg/h.

The machines are of *average* quality and suffer significant wear; however, almost all parts can be repaired locally in a typical workshop possessing a simple lathe.

So once all the down time and re-starting for normal operations (charge, discharge, clean, etc.) was taken into account, the effective capacity for an entire day's work was around 40 kg/h per machine. This is not sufficient, so we are forced to look for larger machines to raise production capacity.

After milling and pelletising, the material is left to dry in the sun and then stored in plastic bags to avoid rehydration.

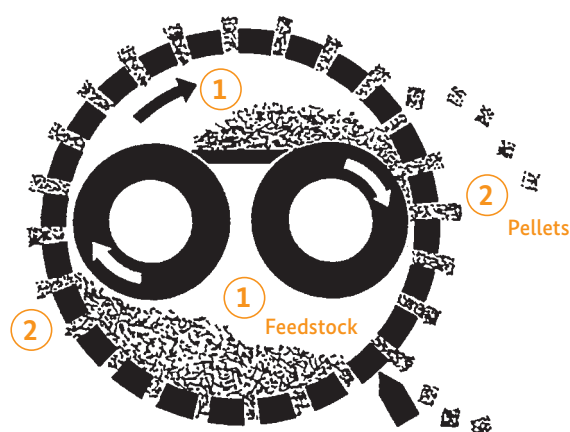

Photo 3.28
Ring die from a small press by AgriconSA

b) Ring-die presses

In a ring-die press, the die comes in a ring / drum shape and moves against 1-3 stationary *rollers* at a rather high speed (> 5 m/sec). This set-up is normally used for larger machines with outputs starting at 200 kg per hour. Ring-die presses are generally more expensive than smaller flat-die presses but are capable of achieving higher outputs per hour, as there are many more holes on the outside walls of the drum-shaped ring die than in a flat die. Most industrial-size pelletising plants use ring-dies. There is generally less torque between the rollers and the die so that wear and tear can be lower on a ring die than on a flat die.

Figure 3.15 Principle of a ring-die press: The die rotates at high velocity; the rollers are stationary but rotate around their axle, thus pressing the feedstock (1) through the lateral holes (2)



The challenge of choosing the appropriate pelletising equipment

In recent years, wood-pellets have become the number-one renewable source for clean thermal energy in Europe, with growing importance worldwide. Pelletising was originally developed as a method for creating uniform, densified animal feeds. Most pellet mills are thus optimised for softer mixes, and they are not designed to make high-density fuel pellets. However, fuel pellets need to be highly compacted and harder

than animal feed so that they do not disintegrate during handling and combustion. The compaction rate is determined by the ratio of the die-hole diameter and the length of the press channel, which is related to the thickness of the die. A longer press channel necessitates more power to push the material through the hole, resulting in a harder pellet. Softer animal feeds require high compaction rates, i.e. longer press channels. On the other hand, it takes less energy to push softer material through a long channel. If the same configuration is used with harder material, the machine may not prove strong enough or the material could get stuck in the die hole. Biomass is a natural material and thus its material properties are prone to vary by season and according to climatic conditions of the harvest year. Straw typically requires a compaction of 1:5, but can vary according to season. The choice of appropriate pelletising equipment is highly dependent on the material specifications of the envisaged feedstock as well as the envisaged scale of operation. Fuel pellets require machinery that can provide enough torque and force for the rollers on the die to push the material through. What is needed is either stronger equipment for fuel pellets or a lubricating component that can achieve a flow-rate similar to that of animal feed.

If moisture is above 16%, the water in the feedstock will boil inside of the pellet mill and make the material soft and soggy, clogging up the machine. Furthermore, these pellets may turn out to be too soft and not suitable as a fuel.

Photo 3.29
Pellets that are too soft and not sufficiently compacted

Common problems experienced with pellet mills

Bjarne Laustsen, the designer of the Jiko Bomba (see [Chapter 4.3.2](#)) attempting to build a pellet-fuel supply for the stoves in Arusha, reports:

“A general problem seems to be that most of the available pellet equipment is designed for production of animal feed pellets, which use relative soft raw materials. Fuel pellets, especially from agricultural residues, are made from harder raw materials. We had good results by adding jatropha press cake to the rice husk for pelletising, or blending maize cobs with velvet beans that cannot be used as animal feed.

I have – by one honest supplier of pellets equipment – been told that for producing fuel pellets, the pellet mills need to have double the power on the motor than most pellet mills have and they need to have a feeding mechanism that can secure an even layer of raw materials on the die. These requirements make pellet mills for fuel pellet production very expensive and the only ones are relative big mills that require a lot of supporting equipments.

We are not able to afford such investments. We have therefore been looking for briquette presses that can produce small briquettes. We have found an Indian supplier that produce a mechanical piston press that can produce briquettes with size diameter 40 mm and length 30 mm. They can be used in our stoves.”

What a manufacturer of pellet mills has to say

Johan Eksteen from Agricon SA, a South African manufacturer of pellet mills for animal feeds reports:

“At Agricon, we test the capacity of our machines on 70 % Lucerne (Alfalfa) and 30 % whole maize grain as we feel this is a very coarse mixture that represents a wide range of materials commonly used for animal feed. We use a 6 x 40 mm die ring as a general guideline for capacity testing. The capacity of any machine may vary radically depending on the material used: a machine rated at 500 kg/h can do between 250 kg to 800 kg/h on exactly the same machine configurations, but with different feeds. So our recommendation when buying a pelletiser is to always enquire from the supplier what the stated capacity refers to. We offer to do a trial with 100 kg of client’s material to deduct an estimated capacity.

Agricon believes that economy of scale is the biggest issue in Africa. Most imported machines are too expensive for the output they are capable to deliver. On the other hand, suppliers don’t realise that Africa has a limited power supply and customers need to be guided in what they can run from their available energy source. Expectations therefore need to be managed. It is also important to be hands-on when it comes to training of new customers, as the perception exists that it is a machine that can be started and left to produce pellets by its own. Then they are disappointed when they find out that reality is very different!

If a roller is tied too much, most pressure is applied on the side where the axle is. It then wedges into the die ring and will create more friction on the axle side of the roller versus the other end. Looking at the picture, it speaks for itself. The purpose of rollers is not to create pressure. They are not supposed to touch the die but create a constant 1 mm layer of feed between the roller and die ring. Most clients set the rollers too tight, causing excessive wear and tear.”



The wear and tear on the dies and rollers is enormous. High silica content and grit in the feedstock act like scouring powder, grinding the die down very quickly. The lifespan of the consumables parts (the rollers and dies) also depends on the quality of the steel alloy, the degree of steel hardening, and the way the machine is operated. If the operator fixes the rollers too tightly to the die, metal will touch metal and wear down a thick die in less than 300 hours. Dies are thick and heavy pieces of

metal that are costly to make and even more costly to ship to remote corners of the world. It is recommended to order a generous replacement package together with the machine in order to save on shipping costs. This can also reduce down-time of the machinery. The running costs for replacing dies and rollers constantly have to be considered when making business plans. Costs can be very high and impact the economic viability of a pelletising business.

Agricon is currently the only known African manufacturer of pelletising equipment with self-regulating feed options that avoid material clogging. Their machinery is designed for less-skilled users. They make larger-scale and robust ring-die equipment focusing on softer animal feed. So far, all their equipment has required 3-phase 400 V power. In order to meet growing demand for smaller pellet-mills Agricon in South Africa is currently developing a 220 V single-phase machine that should be able to process 200 kg of softer material per hour. The throughput for fuel pellets is expected to be lower than that, perhaps around 100-200 kg.

For further information see: <http://www.agricon-pelleting.co.za>

Pelletisers need to be combined with hammer mills or other sizing equipment to create the right-sized feedstock. This increases the need for capital investment, which can be a significant barrier to venturing into a trial phase for testing the feasibility of a pelleting business. In such cases a rather small-sized *all-in-one* machine is recommended.

Ecworxx in Germany started producing *all-in-one* pelletisers with an included grinder in 2010 (http://www.ecworxx.de/index_en.html). The machines are designed for small-scale applications but have proven promising during initial trials. Required electricity input is only 3 KWh for the smallest unit but must be tri-phase 390V. They are all flat-die machines allowing for dies to be exchanged easily and experiments to be done with various pellet diameters in order to find the optimal size and thickness for the dies. They are shown in operation at: <http://www.youtube.com/watch?v=0B8ln7wv-Nk>

Some manufacturers in the USA also have single-phase equipment running at 220 V, such as: <http://www.pelletpros.com/id68.html> or <http://www.buskirkeng.com>

Photo 3.30
Broken die after
600 hours of use
(700 mm diameter,
65 mm thickness)

Where to purchase pellet mills?

Suppliers of pellet mills should be selected according to the continent and the availability of after-sales services. The following is a non-exhaustive selection of pellet mill manufacturers for fuel pellets which were all visited by the author in May 2013 at the LIGNA expo in Hannover, Germany.

→ Smaller machines for pilot phases or start-ups:

- Ecoworxx (Germany), produces small, energy-efficient, all-in-one pelletisers with flat dies from 50-250 kg/h
<http://ecoworxx.com/en/produkte>
- SmallPelletmill (Czech Republic) 10-150 kg/h
<http://www.smallpelletmill.com>
- NovaPellet (Italy) from 50-250 kg/h
<http://www.novapellet.it/inglese/index.htm>
- PSystems (Italy) hydraulic ring-die presses from 80 - 1,250 kg/h
<http://www.psystemsrl.it/en>

→ Medium-large, industrial-scale machines:

- Gama Pardubice (Czech Republic)
<http://gama-pardubice.czechtrade.us/pellet-press>
- Sweden Power Chippers AB (Sweden) 125-1,000 kg/h
<http://www.pelletpress.com/Pellet-press.htm>
- Friedli AG (Switzerland) 150-1,500 kg/h
<http://www.friedliag.ch/pelletieren/Pelletieren/Pelletizer%2BC-Series.htm>
- Nawrocki (Poland) 150-3,000 kg/h
<http://www.granulatory.pl/strony/1/en/1110.php>
- Amandus Kahl (Germany) 300-8,000 kg/h
http://www.akahl.de/akahl/en/products/biomass_pelleting/index.php
- General Dies (Italy)
<http://www.generaldies.com/index.php?lang=eng&blk=azienda>
- Muench Edelstahl (Germany)
<http://www.muench-edelstahl-gmbh.de/pelletpressen.html>

→ Above 2,000 kg per hour:

- Salmatec (Germany)
<http://www.salmatec.de/en>
- Promill Stolz (France)
<http://promill.fr/en/index.php>
- Andritz Feed and Biofuel
<http://www.andritz.com/products-and-services/pf-detail.htm?industryid=1195555&pid=13502>

The economy of pelletising: A report by Gregor Kraft from Bauerpower (Germany),
<http://www.bauerpower.de>

"Since 5 years, I use a flat-die pellet press from Gama to pelletise mainly cereal straw from farmers in the region. The capacity of the machine is stated by the manufacturer with 3.5-4 tonnes per hour, which is true for animal feed. For 8 mm straw-pellets, I only manage an output of 1 t/h. My biggest customers are horse stables who use the pellets as litter. I use them as fuel in my HotTube fireplace inserts, with a clean flame and power outputs ranging from 2.5 to 9 kW per hour, depending on size and fuel filled (see photos in [Chapter 4.1.8](#)).

I buy baled straw from farmers in the region in truckloads. A truck with a 12 m trailer can carry between 12-15 tonnes of straw. A round bale weighs 200-250 kg; I can store up to 250 of them in my hangar. With the forklift I can feed the bales into the breaker that can grind up one big bale in 10-12 minutes so that I get the same throughput of 1 t/h as the pellet mill. Two straw mills from the German animal feed specialist Himel (http://himel.de/index.php?route=product/product&path=17_99&product_id=48) cut the material in two steps to the final size of 8 mm. There is a large increase in volume when milling the straw down to 8 mm sizes, and I found that I could manage the material flow better by using two straw mills in a row. The finely milled straw is blown into a large buffer container. It is very important to have enough buffer volume so that I can dose the material flow into the pellet press properly. With a controlled constant feed into the pellet press, I reduce the risk that the pellet press runs dry. On the way to the pellet press I can add water and other additives, if required, to the feedstock.

Figure 3.16 Material flow and power input when pelletising 1,000 kg of straw per hour

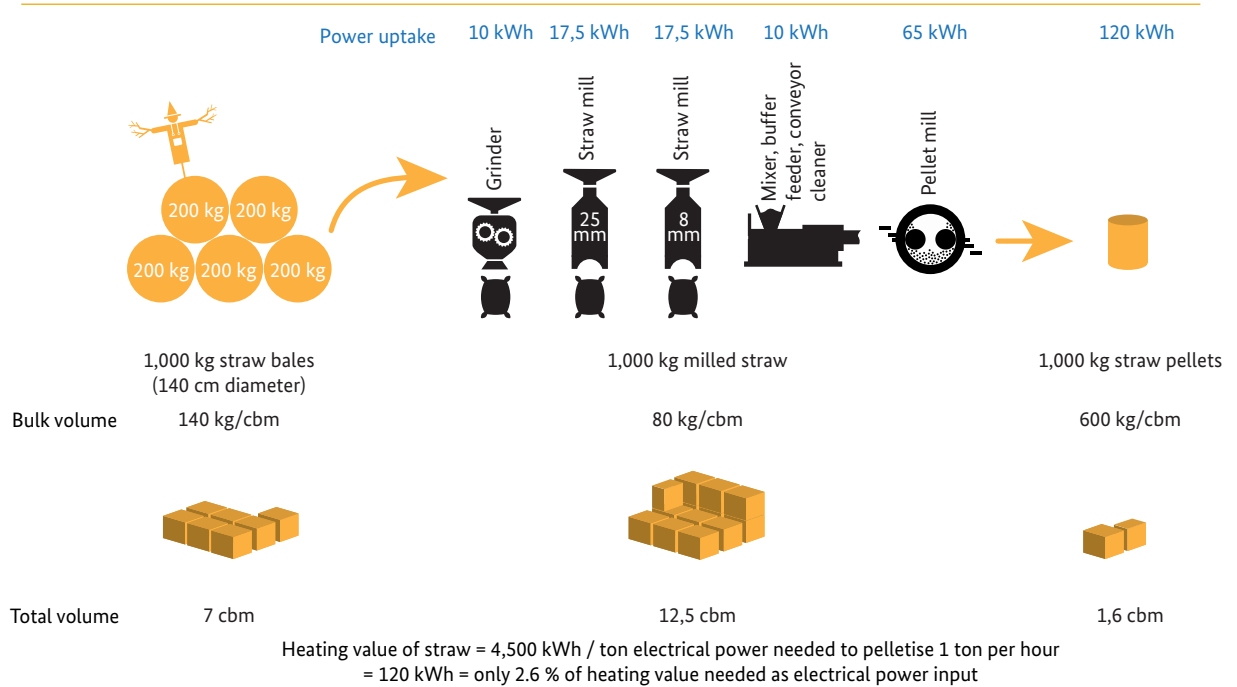

Based on the example by Gregor Kraft, Bauerpower Germany (2013)

My machine has a rotating flat die with 70 cm diameter, and 3 stationary roller heads fixed on a vertical shaft. Only the outer sleeves of the rollers move. The volume of the chamber above the die is quite large, which is ideal for the bulky straw and stalks. I have different dies with different hole diameters from 6 mm, 8 mm, 10 mm and 20 mm. They also vary in thicknesses: wider diameter holes need thicker dies. For straw pellets,

I usually use a die with a thickness of 65 mm, depending on the straw properties and the intended use of the pellet. The holes have a diameter of 8 mm and are bored in a funnel-shape on top. That assists the material flow, pre-compacts the feedstock and guides it into the hole. The exit at the bottom of the die is also wider than 8 mm so that the length of the actual press channel with 8 mm width is only 35 mm, or a compaction ratio of 8:35 mm. If I want a higher compaction, I use a die with longer press channels up to 45 mm or a different hole geometry. It is expensive to have different dies, but for my work it is necessary to be able to adapt to the different feedstock properties and customers' needs.

A vibrating sieve removes the fines which go back to the pellet press. The pellets are cooled on a conveyor on the way into a big-pack for transport.

To run the complete set of machines I usually need 110-130 kWh to produce 1,000 kg of pellets with an energy value of 4,500 kWh. This means that I invest less than 3 % of the heating value in the form of electrical power to create the pellets.

The biggest challenge is to get the flow of material right and cope with the changes in volume during the processing. The figure gives you a visual impression of the challenge. I can process about 6-10 tonnes per day if all goes well and I have no breakages. The rollers and dies do wear out. They are consumable parts and need to be replaced regularly. I always keep some spares in stock so that my production is not disrupted for too long.

A pellet press cannot run without supervision; it needs skills and experience to operate it. I have learnt in the 5 years with the machines to detect irregularities just by sound. Even with my experience it can still take me a day or two to find the right settings of all the machinery until I manage to produce good pellets to the desired specifications. There are so many parameters I need to adjust: the speed of each component to get the right degree of milling and a smooth flow of the material from the grinder via the straw mills to the pellet mill. I also need to find the right moisture content of the feedstock, select the appropriate die and roller heads and adjust the rotating speed of the die. I also need to adjust the distance between the rollers and the die to avoid that the material forms a carpet on top of the die that makes the rollers to slip on top without the torque and grip to push the material into the holes. These are just the most important parameters to constantly observe and adjust to create a good pellet.

My set-up of machines costs around 160,000 EUR including the reconditioned second-hand pellet mill. I was involved designing a mobile pelletising unit mounted on a tractor-trailer, to take the unit to the place where the feedstock is. The unit includes all necessary elements: generator, straw-bale breaker / grinder, straw mills, buffer, pellet mill and conveyors. Depending on the configuration, it costs no less than 300,000 EUR."

Watch a video in German on: <http://www.youtube.com/watch?v=kTfl1edpAL4>

Table 3.4 Summary of benefits of densified fuel for use in micro-gasifiers

	Advantages	Disadvantages
Fuel USER	<ul style="list-style-type: none"> • Easy and clean handling • more heat per batch load or longer cooking period with the same size and volume as the fuel container • less handling tasks • predictable performance • uniform properties • better storability (easy to stack) • less storage space needed • less moisture • fuel ready to use (like charcoal) • fewer transportation issues • fewer transaction costs • fewer insects in the fuel. 	<ul style="list-style-type: none"> • Densified fuel is more expensive than <i>natural</i> fuel.
Fuel PRODUCER	<ul style="list-style-type: none"> • Add value to biomass residue materials • reduce transport requirements. 	<ul style="list-style-type: none"> • High investment costs for densification equipment • less affluent collectors of natural biomass fuels might not participate in densification value chain.
Environment	Groundnut shells, straw, hay.	<ul style="list-style-type: none"> • Organic material used as fuel instead of green manure on the fields; can be overcome by feeding biochar and/or ash back into the soil.

Gasifier cookstove diversity

4.0

4.0 Gasifier cookstove diversity

As explained in *Chapter 2*, a cookstove is an assembly of parts that work together and enable clean and efficient cooking: these include a burner unit and a heat-transfer structure.

It is of utmost importance for stoves to adapt to the people who use them as well as their cooking habits, and not the other way round! Therefore, every stove should:

- satisfy the cook – convenience of use, speed, provide a level of heat suitable for local dishes, cultural acceptance, keep the time needed to tend to the fire at a minimum, etc.
- use locally available, reliable and affordable fuels (reducing burdensome fuel preparation efforts)
- be affordable – local manufacturing from locally available materials or be imported at reasonable cost.

This chapter discusses the different applications for biomass gasifiers in cooking. The first part, *From theory to practice*, presents options for experimenting with do-it-yourself models, ready-made camp-stoves and fireplace inserts.

Photo 4.1

Displaying various micro-gasifiers at a stove camp in Italy

(from left to right: iCan, Woodgas Campstove, HotTube, PekoPe energy unit, Champion, TChar)

It is followed by a (non-exhaustive) catalogue of commercially available gasifier cookstoves from around the world, arranged into three categories:

- stoves for chunky fuels (natural draft and fan-assisted)
- stoves for rice husk (natural draft and fan-assisted)
- devices for biochar creation in developed countries.



Most models follow the basic TLUD principle that is not protected by any existing patents or copyrights. Please note that the author does not have commercial interests in any of the models presented here – the selection was not made based on any personal bias. Inclusion criteria in this edition were:

- external feedback pertaining to the stove provided to the author by November 2013
- a minimum of 100 units in use
- design with domestic cooking and not space heating in mind (firepower < 10 kW).

4.1 From theory to practice – gaining own experience

The models presented here are not recommended for use in daily cooking; rather, they are appropriate for gaining one's own experience as well as demonstrating biomass gasification principles. People who want to make gasifiers from simple tin-cans on their own can follow the *do-it-yourself* instructions. For others who prefer a ready-made and functioning model, camp-stoves and fireplace inserts are available via mail-order.

Tincanium models are very educational and can spark interest in developing a sense for experimentation with gasification. They are:

- cheap – relying on existing construction elements like discarded tin-cans
- easy to construct – having step-by-step instructions for people without tin-smithing skills
- low-tech – requiring few tools other than a *church-key* can-opener, tin-snips and nails
- easy to use – based on natural draft, with no electricity needed for operation.

Prototypes based on tin cans are replicable, modifiable and adaptable to existing stove bodies, thus being a great tool for demonstrating the technical concepts and general viability of micro-gasification through simple means. They could serve to build local trial versions in a new area and inspire adaptation by local artisans and users. However, please wear gloves when handling tin cans as the edges can be very sharp.

Further reading

- *Make Your Own Biochar Stove - Quick & Easy* e-book by Kelpie Wilson
The growing interest in biochar has been an important driver for many recent applications of pyrolytic gasifiers. In the future, our attitude may change from: *Get your carbon out of my atmosphere to Help me get that carbon back in my soil*. It contains construction templates and clear step-by-step instructions on how to build and use functional biochar stoves following TLUD principles.
<http://www.biochar-ebooks.com>

Photo 4.2
Young kids in Uganda
observing tincanium
gasifiers



In addition to a general overview on tinanium options in Kelpie Wilson's e-book, four models for easy-to-make and well-documented do-it-yourself *burner concepts* are presented here (see [Table 4.1](#)). They are all able to produce char but differ in their ability to pre-heat secondary air as well as their inclusion of a concentrator disk for thorough gas-air mixing.

Table 4.1 Four do-it-yourself burner concepts described in this manual

Do-it-yourself burner concept	iCan	Toucan	EverythingNice	Grasifier
Pre-heated secondary air	No	No	Yes	Yes
Concentrator disk for thorough mixing of wood-gas and air	No	Yes	Yes	No
Described in section	4.1.1	4.1.2	4.1.3	4.1.4

Gasifier campstoves and fireplace inserts are ideal for people who prefer ready-made devices that can be ordered via mail, paid for electronically, and shipped to remote corners of the world at reasonable cost.

Campstoves are designed to be light, compact and sturdy enough to endure regular transport in a backpack. They can utilise nearly any type of dry biomass fuel found outdoors without the need for chopping (leaves, twigs, pine cones, straw, etc.). These stoves are rather pricy and therefore mainly targeted at a more affluent niche market for occasional use, such as warming food on a camping trip. Campstoves are not designed for preparing meals that require vigorous stirring or large pot sizes that are prevalent in developing countries.

Fireplace inserts allow for the use of pellets in an existing fireplace that is meant to burn wood-logs, without the need to invest in a costly heating stove specially designed for pellet use. While there are many fireplace inserts for pellets that conveniently run for at least an hour on one full load without the need for refilling, not all of them accord to the TLUD gasification principles.

This selection presents campstoves with natural draft or fan and natural draft TLUD fireplace inserts.

Table 4.2 Ready-made devices described in this manual

Ready-made devices obtainable via mail-order	Campstoves			TLUD fireplace insert
	With fan and heat-control options	Power supply	Described in section	
With fan and heat-control options	No	Yes	Yes	No
Power supply	No	Battery	TEG	No
Described in section	4.1.5	4.1.6	4.1.7	4.1.8

4.1.1 *iCan* concept presented by Jock Gill

This is a very simple, all-in-one TLUD made of a single tin can with 17 holes cut into the right places on the can. No tools are needed for construction other than a can opener and a nail or a punch. The construction of the stove takes less than 10 minutes. It is very suitable for school projects to demonstrate the TLUD principle and have people cook something on a stove that they just made with their own hands.

Further reading

- Instructions for building an *iCan*:
<http://stoves.bioenergylists.org/content/peacham-ican-tlud>
- Updated instructions:
<http://stoves.bioenergylists.org/content/general-purpose-ican>
- Experience with pyro-grilling:
<http://biochar.bioenergylists.org/pyro-grill>
- More designs by Jock Gill: <http://stoves.bioenergylists.org/search/node/Jock%20Gill>

4.1.2 *1G Toucan* by Hugh McLaughlin

This is probably the second simplest TLUD micro-gasifier available, being essentially comprised of two cans placed on top of one another. A 1-gallon (*1G*) paint can and another slightly smaller can (referred to as a *coffee can* in the USA) for the secondary air are typically used in this construction; a third can may be added as riser. The *Toucan* is very educational and can clearly demonstrate the TLUD principles. The combustion zone is well visible, making the convection flows and flame shapes easy to view and understand.

The *Toucan* is well suited for the production of small quantities of consistent, highly pure and easy-to-use biochar. This is due to its unique construction features: primary air is fed through the bottom of the *1G* can (which is slightly raised e.g. by small nails). Secondary air enters through the coffee can on top. The main fuel container does not have any air holes on the sides; once it is placed directly on the ground and covered with the paint can lid, air can no longer reach the hot char, preventing it from burning down to ash. This ensures that char can be both safely and easily saved inside of the container without having to quench it with water or dump the glowing char out of the hot container at the end of the wood pyrolysis stage. The *Toucan* is a good and powerful burner unit, also ideal as a make-shift stove or water-heater for camping and for emergencies during power outages. Furthermore, it can also make a practical and simple fireplace insert.



Photo 4.3
Various 1G Toucans
with risers at CHAB-
camp in Massachu-
setts in August 2010

Further reading

- Explanation on how to make high and low-adsorption biochars for research:
<http://www.acfox.com/BiocharsForResearch.pdf>
- 1G Toucan TLUD for biochar, production instructions at:
<http://www.acfox.com/1GToucan.pdf>
- More information at: <http://stoves.bioenergylists.org/mclauglintonoucan>

Further developments include the Toucan Flex – a versatile TLUD that provides a heat source for various applications based on a 5-gallon (20l) pail – and the Toucan MR (micro-retort) – using any two tin cans of the same size.

4.1.3 Everything-nice Stove by Nathaniel Mulcahy

This model is made out of two cans with slightly differing diameters so that one can may fit inside the other. This will leave a small gap for pre-heated secondary air. The design is size-flexible and can be made anywhere in the world from existing cans. The publication of the instructions with flexible and relative measurements in 2009 lead to multiple versions tested all over the world. Many of them are demonstrated in countless videos on YouTube.

This model is ideal for fitting a gasifier burner unit inside of an exist stove and creating a multi-fuel stove – such as the charcoal stove from Benin depicted below that was retrofitted with a burner unit from standard European sized cans of 425 ml or 580 ml and fuelled with straw pellets. The stove may still be used with charcoal as long as the riser hole in the gasifier burner is covered with a perforated piece of metal that functions as a grate.



Photos 4.4 + 4.5
Everything-nice
burners retrofitted
in a charcoal stove
from Benin

Further reading

→ Demonstration of the models: <http://worldstove.com/album/your-versions-of-the-everythingnice-stove>

4.1.4 *Grasifier* by Crispin Pemberton-Pigott

This design is based on the *Vesto* principle (see [Chapter 4.2.13](#)). It can burn grass pellets as well as a wide range of other solid fuels.

Secondary air is pre-heated between the internal double walls all the way up to the top of the combustion chamber, well above the secondary air entry holes. Jets of pre-heated secondary air *shoot* into the combustion chamber through small holes and thoroughly mix with wood-gas. The burner unit does not have a concentrator disk but still burns cleanly. The stove also manages to keep the flames rather low above the fuel bed, which is good to radiate heat back into the fuel to assist pyrolysis.

This *grasifier* is well suited for demonstrating the viability of grass-pellets as a cooking fuel, a potentially important source of solid biomass energy in developing countries. The construction can be completed within 30 minutes by users with some metal-working skills and simple tools, including tin snips, a sharp punch, a hammer, a fat washer for making *spouts* (rather than just holes) and a ruler or tape measure. The designer has estimated the material cost of the combustor to be about 1 USD to produce with thin stainless steel.

Further reading

→ An article on the TLUD *Vesto* *Grasifier*: <http://stoves.bioenergylists.org/vestograsifier>

→ Construction descriptions for a 1.4kW *grasifier* with video:
http://stoves.bioenergylists.org/crispin_25-kw-grasifier

4.1.5 Natural-draft campstoves

The **Solo stove** is a compact (10-cm high, 11-cm wide), double-walled stainless-steel stove that only weighs 255 g. It is available in two versions in the USA for a price starting at 69 USD onwards (<http://www.solostove.com> or in Europe via amazon).

The **Bushbuddy** originates from Canada and has features and accessories similar to that of the Solo stove. It is available in both regular and ultralight versions at:
<http://www.bushbuddy.ca/index1.html>

The **SilverFire Scout**, a compact 255 g natural-draft backpack stove, will soon be on the market. More information can be found at: <http://www.silverfire.us/stoves>

4.1.6 Fan-assisted campstoves powered by a battery pack

The Tom Reed Woodgas Campstove

This first commercially available *TLUD* was designed by Dr Tom Reed and Shivayam Ellis for mass production. It was made available 2003 as a stainless-steel campstove with a fan powered by a separate battery pack with two AA batteries. It allows for heat to be controlled by choosing between two sockets for high and low fan speeds. It keeps the flames rather low and also allows for refuelling during operation. Tom Reed designed several different models: the WoodGas LE (weight 655 g, height 16 cm, diameter 13 cm) as well as the XL and XXL versions. Over 5,000 units have been sold since 2003. As of November 2013, the Biomass Energy Foundation (BEF), which had previously attended to the mail orders of the stove, has ceased to exist and the stove is therefore no longer available. The Woodgas LLC is being reorganised with additional partners in order to continue the supply of Reed Woodgas Campstoves. News will be announced in the BEF section of the following website (www.drtlud.com), or an update can be requested by contacting shivayam.ellis@gmail.com

The **ZZ Sierra stove** has a single AA battery that powers an adjustable-speed fan, creating a forced ventilation system that provides both intense heat and efficient burning. The stove can be nested inside of a kettle for easy transport with a backpack. It is available starting at 57 USD without accessories (<http://www.zzstove.com/sierra.html>).

4.1.7 BioLite CampStove: a fan-assisted campstove powered by a TEG

The BioLite CampStove is a compact, fan-assisted biomass gasifier that uses thermoelectric technology to convert waste heat into on-demand electricity. Designed for outdoor adventures and emergency preparedness, the BioLite CampStove is an award-winning product that has been recognised for its ground-breaking technology. Relying on locally gathered biomass such as twigs and pinecones, the CampStove provides an ultra-efficient fire, is the first self-powered stove of its kind and allows users to charge small devices ranging from LED lights to high-end smartphones via an on-board USB port. A thermal electric generator powers the on-board fan without any need for batteries, solar panels or access to grid power. Excess energy can be used to power most portable USB devices. The stove's unique design allows for it to be packed up, with retractable legs and the trademark PowerPack *nesting* within the stove chamber. A unique mesh heat-shield allows for handling of the stove even after an hour of continuous burning; no accidents have been reported to date. This campstove is a universally well-received, reviewed and highly rated high-end consumer product.

Further reading

- Company website: www.biolitestove.com
- Performance data:
<http://catalog.cleancookstoves.org/#/stoves/65>
- Testimonials:
<http://www.biolitestove.com/campstove/camp-stories/camp-stories-all>



Boiling time: 4.5 minutes to boil 1l of water. **Fire power:** 3.4 kW (LO), 5.5 kW (HI). **Electricity output:** USB Power Max continuous: 2 W @ 5 V, peak: 4 W @ 5 V. Powers most USB-chargeable devices, including LED lights, headlamps and smartphones. **Charging time:** (iPhone 4S on 2G): 20 minutes of charging provides 60 minutes of talk time. Packed size – height 21 cm, width 12.7 cm, weight 33 935 grams.

The stove has been produced since 2012 by BioLite LLC based in Brooklyn, New York. It has a one-year warranty and can be paired with BioLite's KettlePot and portable grill products for increased cooking versatility. Many tens of thousands of units have already been retailed globally in over 70 countries. The stove is available for 129.95 USD.

Photo 4.6
BioLite CampStove
(BioLite)

Further reading: BioLite applies the same principle of the TEG-forced air system to their HomeStove, which creates a unique combination of forced and natural draft to better control the pyrolysis and combustion zones. This set-up enhances combustion efficiency closer to that of a gasifier than a typical rocket stove: the introduction of forced secondary air from the on-board fan back-pressures and reduces natural draft in the stove, which starves the primary combustion zone of oxygen. The emitted fuel-rich gas is then burnt with the turbulent secondary air at an optimum ratio and with high mixing and combustion efficiency.

Although the HomeStove is designed as a front-loading stove for stick-shaped solid dry biomass, it can burn other more granular, small-sized biomass as well. More feedback will be available in 2014 after the end of the pilot phases in India and Sub Saharan Africa. Test results by renowned laboratories should also be available soon. They are expected to show similarly low emission rates as well functioning gasifier stoves. Read more at: www.biolitestove.com/homestove

4.1.8 TLUD fire place insert HotTube by BauerPower

The HotTube is a robust 2-piece fireplace insert designed by Gregor Kraft. It enables the clean burning of pellets composed of straw and many other residues in existing fireplaces meant for wood. Gregor Kraft's company BauerPower transforms many types of renewable biomass resources into pellets. Due to the nature of feedstock with high ash content, the pellets do not comply with the DIN norms required for modern pellet-powered, space-heating stoves that are optimised for wood pellets. The amount of fuel filled into the HotTube determines the duration of the flame. The stove combines the beauty of a clean, stable and consistent flame with ease of handling: filling fuel and emptying ashes are just as easy as lighting it. The HotTube can also be used for producing biochar, granted that the char is quenched after the pyrolysis phase. It is clean-burning and goes out without producing smoke. As the flame remains constant for a long time, the HotTube is quite versatile and can also be used for cooking, lighting, heating and even for a carbon-negative barbeque.

The HotTube and accessories can be ordered in different sizes from 2 to 9 kW of fire-power via: http://www.bauerpower.de/bauerpower_hottube.pdf

Photo 4.7
Filling and lighting
a HotTube
(BauerPower)



Photo 4.8
HotTube fireplace
insert with a flame-
deflector



Photo 4.9
HotTube placed in
a chimney-stove
for wood



Photo 4.10
HotTube as lamp and
barbeque
(GIZ/Breiholz)



Photo 4.11
HotTube as outdoor
patio lamp



4.2 Catalogue of natural-draft stoves for chunky biomass



Chunky fuels (such as wood chips, briquettes, pellets, etc.) allow for sufficient natural air-flow through a fuel by way of natural draft (ND). Most ND stoves are easy for local tin-smiths in developing countries to replicate, even without electricity access.

A special tribute should be paid to Paal Wendelbo and his ND PekoPe design. It is the oldest known TLUD concept applied in a developing country. It was invented by Paal Wendelbo in Africa in the late 1980s. After much trial and error, Paal Wendelbo made a simple gasifier cook stove which was found to be very clean burning in tests conducted at the Copenhagen Technical College in 1988. Since then, the stove has been introduced by Paal in Malawi (1988, fuelled with grass), Mozambique (1990, fuelled with cashew nut husk), Ghana (1989, fuelled with residues and chopped wood) and Tanzania (1990).

Photo 4.12
Early stage PekoPe from 1988 (Wendelbo)



Photo 4.13
PekoPe in Uganda (Wendelbo)



In 1994, the stove was used in refugee camps in Uganda with straw as the fuel. The straw was bundled and packed vertically the unit without problem (i.e. peko pe) in the venacular of the Acholi tribe. More than 5,000 units had been sold, but once Paal had left Uganda the design was forgotten. It was rediscovered in 2009 when Paal attended a stove camp in Aprovecho and the PekoPe was honoured with an award.

In all the countries where the stove was introduced, local tin-smiths constructed the PekoPe using hand tools and locally available and sourced materials – either new sheets or scrap metals. The artisans only needed rough guidelines, a template and customers for this simple technology.

Photo 4.14
A large-scale PekoPe energy unit powering an institutional stove



Photo 4.15
PekoPe user in Zambia
(Miombo)

Technical features: The *energy unit* consists of an inner cylinder that serves as the fuel chamber (or reactor), an outer cylinder to guide and pre-heat secondary air, and a concentrator disk on top. Two vertical handles on the outside cylinder ease handling and the dumping of char. The inner container is fixed to the outer container with spacers that double as legs to keep the fuel chamber above ground and let secondary air enter between the cylinders. The concept is scalable to larger diameters.

The construction still requires a pot-support or any other heat transfer structure that is adapted to local needs.

Handling: top-lit, batch-fed, cooking time depends on volume and mass of the fuel – up to 75 minutes are well possible. In order to extend cooking time, the entire energy unit can be exchanged. Combining more units under one pot support increases fire-power e.g. for use in restaurants, industries or institutions.

The PekoPe has the following advantages:

- likely the simplest TLUD design with the longest proven field-experience
- a very clean-burning, pyrolytic TLUD gasifier *energy unit*
- char-making is optional – the user can choose whether or not to use energy for cooking or save the char for another use
- very simple to make using any type of metal and ideal for replication
- the stove can be scaled from household sizes to institutional and commercial sizes.

Paal Wendelbo always emphasises that you *have to start with the fuel*, as he believes that *fuel, stove and user are one system, which cannot be separated. If you don't have the fuel at an appropriate price, you will not manage to promote the stoves.*

Today, the NGO Miombo promotes the PekoPe in various countries, either as an artisanal version or as a local product using imported flatpacks (as described in [Chapter 4.2.1](#)).

Further reading

- Discussions on PekoPe technology can be followed at:
<http://stoves.bioenergylists.org/taxonomy/term/1807>
- The PekoPe has been disseminated in Zambia by the organisation OSCAR since 2009:
<http://projectoscarinzambia.weebly.com/the-peko-pe-stove---alternative-household-energy.html>
- The original PekoPe was tuned to function well with bundled grass in northern Uganda. For further information please watch the following videos:
<http://www.youtube.com/watch?v=amaUDK6VyRg>
<http://www.youtube.com/watch?v=gi3Xx7NtTGw&feature=related>
<http://www.youtube.com/watch?v=dsfuVGBi4fc&feature=related>

PCIA Lifetime-achievement Award 2011 for the two forefathers of TLUDs

The practitioner Paal Wendelbo and the academic Dr Tom B. Reed, who scientifically developed and described early inverted downdraft systems, are considered to be the two *forefathers of TLUDs*. They were awarded with a joint *Lifetime Achievement Award* by the PCIA in Lima in 2011 for their lifelong innovative work on gasification. Their work serves as the foundation for TLUD concepts which are nowadays recognised as breakthroughs in the clean burning of solid biomass.



Photo 4.16
The *forefathers of TLUD cooking* in 2011 in Lima

(from left to right):
The award-winners
Paal Wendelbo and
Dr Tom B. Reed, with
Paul Anderson
(a.k.a. *drtlud*)

In the following sections, various natural-draft gasifiers will briefly be introduced. This section is meant to demonstrate the progress that has been made by the international stove community since the early days of Paal Wendelbo and Tom Reed.



Photo 4.17
Paal Wendelbo working on the PekoPe at his home in Norway (Wendelbo)



Photo 4.18
Assembly of the
PekoPe from pre-cut
material
(V. Wendelbo)

4.2.1 PekoPe 1 flatpack assembly

Target area:	Any developing country
Fuel type:	The stove is fuel flexible and accepts most biomass-based materials: pelletised, chopped, hacked and also pelletised sewage.
Designed by:	Paal Wendelbo (Norway).
Retail price:	Price depends on materials used and on the local context.
Units sold:	Over 5,000 since 1995.
Start of production:	Originally in 1995 in Uganda; replicated in many places around the world.
Manufactured by:	Several flatpack producers, local assembly of flatpacks.
Contact:	Technical: Paal Wendelbo paaw@online.no Project implementation: Terje Hoel: terje@miombo.no and Jan Sorensen jan@miombo.no
Address:	Miombo AS, Nannestadveien 54, 2034 Holter. www.miombo.no
Production capacity:	50,000 - 100,000 / year. Stove assembly of flatpacks dependent on local capacity.
Short description:	The PekoPe is a TLUD natural-draft gasifier / pyrolysis household energy stove for use in clean cooking. Its primary characteristics are clean burning operation and flexibility with regard to different types of fuels.
Features:	Designed for local assembly based on flatpacks; available in various sizes and materials (e.g. also with a shiny surface); recent stove developments include a temperature regulator and the option for a thermoelectric generator.
Handling:	Batch-fed from top, top-lit.
Char-making ability:	Biochar yields are 20-25 %.
User feedback:	Quickly adopted by users for its clean cooking, portability and low running cost through the reduced use of fuel; the stove is viewed as attractive since it is constructed from materials that provide a long lifespan and it also requires a simple stove construction; tin-smiths find it easy to assemble the stove from pre-cut material.
Performance data:	Results from testing at the US EPA laboratory in 2013 expected soon.
Further info:	The stove dates back to the early 1990's when it found wide distribution among several projects in a refugee camp in northern Uganda in 1995. See www.miombo.no for more information on the stove.

4.2.2 Champion stove (India)

The Champion – TLUD ND (natural draft) stove by Servals is based on Dr Paul Anderson’s TLUD design that won the award for the cleanest-burning stove at the Aprovecho Stove Camp in Oregon in 2005. Artisanal versions of this design are already in use in several countries, driven by the fact that they can be easily and cheaply manufactured locally. The reasonably priced assembly with two exchangeable fuel canisters and a pot-stand from Chennai is ideal for testing the suitability of TLUD gasifier technology in a new area.

Photo 4.19
Champion stove: full set with tripod and two fuel canisters (Servals)

Target area:	India, export upon request.	
Fuel type:	Any chunky, dry, solid biomass.	
Designed by:	Dr Paul Anderson.	
Pricing:	Special pricing for development projects Ex-factory in Chennai: set of 2 canisters for daily cooking + 1 tripod at 2,200 INR.	
International availability:	Developed world prices Ex-factory plus shipping costs from Chennai for 1 canister + tripod: 40 USD, second fuel canister: 25 USD Outlets in countries outside of India (pricing upon request): USA: http://www.greensteadors.org/biochar/index.html Slovenia: http://permakulturazatelebane.wordpress.com Australia: via Paul Taylor potaylor@bigpond.com http://biochar-books.com	
Units sold:	Around 3,500 (of which 2,500 have been sold with a carbon subsidy; 2,500 more are to be covered under the same project in early 2014 – project size = 5,000).	
Start of production:	2009.	
Manufactured by:	Servals Automation Pvt. Ltd.	
Contact:	sujatha@servals.in	
Address:	Servals Automation Pvt. Ltd, Chennai - 600 032, Land line: + 91 44 64577181/82, Fax: + 91 44 45540339 http://servalsgroup.blogspot.in	
Production capacity:	Can be scaled-up on demand.	
Short description:	The Champion is a batch-loading, top-lit updraft stove with double-walled fuel canisters. Secondary air enters without regulation between the walls through an opening at the front. A complete package for developing countries comprises of two canisters (to extend cooking time), one concentrator lid, and a sturdy tri-pod pot-stand with pot-rests and a telescopic riser (connector assembly) that can slide down and be coupled with the concentrator lid. The containers, lid and coupler are made of stainless steel. Dimensions: width 200 mm, height 280 mm, weight of fuel container 1.6 kg.	
Features:	<ul style="list-style-type: none"> • Cone-shaped controller for regulation of primary air. External fan optional. • Riser provides draft and directs the flame to the pot, protects against wind and provides space for complete combustion. • Optional charcoal-burning accessory can be added for simmering with the created char. 	
Handling:	Canister filled with fuel, one layer of fire-starter material placed on top; lit at the top, canister placed in the stove structure under the pot (can be the tripod or any other structure); there is a second fuel canister available to extend cooking time once the first fuel load is finished.	

Char-making ability:	Char can be preserved by emptying the container after the end of the pyrolysis. It is easy to dump the char out since the fuel container has a handle and is separated from the stove structure holding the pot. Char yields are typically 20% weight and 50% volume of original fuel.
User feedback:	Detailed feedback from 50 households in Sunderbans (India) can be found at: http://www.biochar-international.org/sites/default/files/Servals-Sapient_TLUD_Pilot_Study-Sunderbans_project.pdf . People like the stove, had no problems with fuel preparation and wanted to keep it after the pilot phase.
Performance data:	Burn time for one batch of fuel depending on type of fuel: over 75 minutes on 1,000 g of wood pellets or 45 minutes on 600 g of wood chips. It boiled 5 l of water without a pot-lid from 11°C in 19 minutes with 384 g of wood pellets or in 20 minutes with 368 g of wood chips at the Aprovecho Research Institute in February 2010.
Further information:	<ol style="list-style-type: none"> 1. The principles of the Champion design by Paul Anderson are shown in detail at: http://www.youtube.com/watch?v=_HPQjvq8Cdw#t=33 2. Information from the manufacturer is accessible at: http://servalsgroup.blogspot.com/2009/05/tlud-gasifier-stoves-wood-stove-with.html Video from the Champion stove used in Australia accessible at: http://www.youtube.com/watch?v=JQqbu4QD9Bs 3. Detailed list and instructions for Champion stove available at: http://www.greensteaders.org/biochar/docs/AssemblyInstructions.pdf 4. More information on the technical features at: http://servalsgroup.blogspot.in/2010/09/charcoal-burning-accessory-for-servals.html 5. A Progress report on the implementation in the Sundarbans can be downloaded from: https://www.atmosfair.de/en/projekte1/projekte00/india-efficient-wood-gas-stoves/ Read the story on page 63/64 in this book. 6. Read about the 2010 CLEAN ENERGY AWARD for TLUD production: http://www.sankalpforum.com/Sankalp/awards.php

4.2.3 MWOTO – the power of fire (Uganda)

Target area:	Uganda and East Africa.
Fuel type:	Uncarbonised chunky biomass.
Designed by:	Centre for Research in Energy and Energy Conservation (CREEC).
Retail price:	Varying from 20,000 UGX (8 USD) to 50,000 UGX (20 USD) as determined by the manufacturer/distributor.
Units sold:	Roughly 3,500 stoves under CREEC’s Biomass Energy in Africa (BEIA) project by September 2012 and continued through project spin-offs.
Start of production:	September 2011.
Manufactured by:	Approximately 60 tin-smiths trained within CREEC’s BEIA project.
Contact:	msabbo@creec.or.ug
Address:	College of Engineering, Design, Art and Technology Makerere University, Kampala, Uganda P.O. Box 7062, Kampala, Uganda + 256 414 532008 www.creec.or.ug
Production capacity:	Varies based on capacity of individual tin-smiths, their companies, groups or associations.
Short Description:	The MWOTO stove is a TLUD gasifier stove based on Dr Paul S. Anderson’s Champion 2008. The design has been adapted based on observations, tests, end-user consultations, field experiences and input from tin-smiths. The outer cylinder is equipped with three feet for stability purposes as well as handles for easier handling of the stove. The pot-rests are incorporated into the stove body (not in a separate tripod).
Features:	Comprised of four components: an outer cylinder, a fuel chamber, a riser / pot stand combination and hooks for handling of the fuel chamber.
Handling:	Fuel chamber has a primary air controller for firepower regulation.
Char-making ability:	The glowing char remaining after the end of the pyrolysis process can be quenched and saved, or transferred into a normal charcoal stove to continue further cooking.
User feedback:	<p>Positive feedback about the stove:</p> <ul style="list-style-type: none"> • cooks much faster than other stoves • produces less smoke than other stoves • uses less fuel than other stoves • saves household fuel costs • generates good quality and quantity of charcoal • is suitable for intensive cooking of meals such as beans, matoke (local plantains eaten steamed or cooked) and cassava. <p>The more negative responses included:</p> <ul style="list-style-type: none"> • the stove becomes too hot • removing the charcoal from the fuel chamber is cumbersome • preparing fuel for the stove is a new and difficult activity • the stove is less suited for cooking foods that require simmering, such as rice and groundnut (or peanut) sauce.
Further info:	<p>1. The MWOTO stove was originally developed by CREEC. Now all MWOTO-related issues are handled by the Uganda MWOTO Stove Association (UMSA) and various manufacturers. A report is available on CREEC’s special MWOTO website: http://www.mwotostove.com/wp-content/uploads/2013/08/BEIA-project-report.pdf</p> <p>2. Watch the MWOTO in a video: http://www.youtube.com/watch?v=PudJD-2_S5Y</p>



Photo 4.20
MWOTO stove
(CREEC)

4.2.4 Karundura gasifier (Rwanda)



In Rwanda, a replica of the MWOTO stove is produced by ENEDOM in Kigali under the name *Karundura stove*. For people using peat as a fuel, the stove is available with increased primary air. One tin-smith can produce 3 stoves per day; 600 have been produced and 300 sold at a cost of 10,000 Rwandan Francs, or approximately 15 USD.

Stoves can be purchased at Muhima Sector, Nyarugenge Dsitrict, City of Kigali, or by contacting Jean Marie Vianney Kayonga at + 250 78 850 1309 or enedom@yahoo.fr

Photo 4.21
(JM Kayonga)

4.2.5 Awamu Quad stove (Uganda)

Target area:	Peri-urban and rural Uganda.
Fuel type:	Chunky dry biomass.
Designed by:	Awamu Biomass Energy Ltd. / Dr Paul Anderson.
Retail price:	16 USD.
Units sold:	700.
Start of production:	October 2012.
Manufactured by:	Awamu Biomass Energy Ltd.
Contact:	Nolbert Muhumuza muhumuza@gmail.com
Address:	PO Box 40127, Kampala, Uganda.
Production capacity:	260 / month.



Photo 4.22
Quad stove
(Awamu Biomass)

Short Description: The portable Awamu Quad TLUD is based on pre-cut parts with *tabs and slots* for easy local assembly without rivets and cheaper shipping as flatpack pieces. It has a metallic body with four wooden handles that allow for safe handling and also serve as legs to provide stability. Flatpacked parts weigh 4 kg; dimensions of assembled stove: 30 x 30 x 50 cm. The Quad can be made as a TChar variation to continue cooking with char.

Char-making ability: Makes 20% hot char from original weight of biomass fuels. Recommended to remove char immediately after pyrolysis.

User feedback: Users enjoy the speed of cooking with less smoke and having hot char made. They also like the fact that it can use a wide variety of biomass waste, but acknowledge that they need to have a ready supply of processed dry biomass fuels to ensure continuous usage of gasifier stoves. If possible, they would prefer continuous loading of fuels.

Performance data: 41-44% thermal efficiency, time to boil 5l of water 27 minutes, 636g of fuel for standard WBT (cold start plus simmer), energy use 11.7 MJ. Turn-down ratio of 1.6 due to primary air control. Stove accommodates 800g to 2.5 kg of biomass per batch depending on bulk density, 35-120 minutes of cooking (depending on biomass density and firepower). The Awamu Quad achieved 81 points out of 100 in a safety test carried out by CREEC according to IWA. This corresponds to Tier 2, a substantial improvement over minimum best practice.

Further reading:

1. Find an introduction with a photo of the stove parts before assembly at: <http://www.drtilud.com/2012/08/03/the-quad-tlud-micro-gasifier-stove>
2. Read about the United Nations Environment Programme 2013 SEED Award in the *Low Carbon* category to Awamu Biomass Energy Ltd at: <http://www.unep.org/NewsCentre/Default.aspx?DocumentID=2752&ArticleID=9673&l=en>
3. Test report of Quad 2 version: http://www.drtilud.com/wp-content/uploads/2012/10/QUAD_2_STOVE.pdf
4. Inquire about the *Troika*, the three-legged newly developed version of the Quad Stove for operation with or without a fan. It is scalable beyond the cookstove size and can be used for biochar production. Plans can be made available by Paul Anderson psanders@ilstu.edu

4.2.6 Prime Square Stove (Indonesia)

Target area:	Exports worldwide.
Fuel type:	Any chunky biomass.
Designed by:	Prof. M. Nurhuda.
Retail price:	Samples cost 30USD, large orders offer discounts.
Units sold:	Approximately 6,800.
Start of production:	2011.
Manufactured by:	CV. Kreasi Daya Mandiri.
Contact:	Prime Cook Stoves, camilla.fulland@primestoves.com
Address:	Storgata 26, 0184 Oslo, Norway www.primestoves.com or post@primestoves.com
Production capacity:	3,000/month.
Short description:	Natural-draft TLUD biomass stove that uses pre-heating, a counter-flow smoke burning mechanism and a co-firing system to improve combustion. Stove dimensions: 27 cm x 27 cm x 37 cm. Approximate weight: 3.1 kg. Fuel capacity: max 1.5 kg of chopped wood, 1.5 kg of pellets. Lifetime: minimum 1 year.
Features:	Interchangeable burning chambers for increased fuel flexibility, primary air control, fire extinguishing system, stove legs for easy handling.
Handling:	Top-loaded, batch-fed stove designed to burn for 1-2 hours depending on fuels. Fuels should be densely arranged in the burning chamber and a space of 5-8 cm at the top of the burning chamber should be left empty to ensure sufficient airflow. Can be refuelled during use, maximum 200g at a time.
Char-making ability:	Char can either be conserved or burnt down to ash.
User feedback:	Flame resembles the flame of LPG. Promising for urban to semi-urban areas. Less chopping required for new model. Easy handling and quicker cooking. Reduced fuel consumption and cost/time spent gathering fuels.
Performance data:	Thermal efficiency level: 38-40% (Gadjah Mada University).



Photo 4.23
(Prime / Nurhuda)

4.2.7 Prime Cylindrical Stove (Indonesia)

Target area:	Exports worldwide.
Fuel type:	Any chunky biomass.
Designed by:	Prof. M. Nurhuda WIPO P00201100604 (2011).
Retail price:	Samples: Regular 30 USD, large 34 USD. Discount negotiable for large orders.
Units sold:	Approximately 6,200.
Start of production:	2012.
Manufactured by:	CV. Kreasi Daya Mandiri.
Contact:	Prime Cook Stoves, camilla.fulland@primestoves.com
Address:	Storgata 26, 0184 Oslo, Norway www.primestoves.com
Production capacity:	3,000/month.
Short description:	Natural-draft TLUD biomass stove that uses pre-heating, a counter-flow smoke burning mechanism and a co-firing system to improve combustion.
Two sizes:	Regular size: 24.5 cm (diameter) x 36 cm (height), weight: 3.1 kg. Fuel capacity: max 1.5 kg of chopped wood, 1.5 kg of pellets. Large size: 28.5 cm (diameter) x 48 cm (height), weight: 4.8 kg. Fuel capacity: max 3 kg pellets. Lifetime: minimum 1 year.
Features:	Interchangeable burning chambers for increased fuel flexibility, separate regulation for primary and secondary air, fire extinguishing system, large size for large households (> 6).
Handling:	Top-loaded, batch-fed stove designed to burn for 1-2 hours depending on fuels. Fuels should be densely arranged in the burning chamber and a space of 5-8 cm at the top of the burning chamber should be left empty to ensure sufficient airflow. Can be refuelled during use, maximum 200 g at a time.
Char-making ability:	Combustion residue: Biochar or ash (depending on air settings).
User feedback:	Flame resembles an LPG flame; promising for urban to semi-urban areas; less chopping required for new model; quicker cooking; reduced fuel consumption and cost / time spent gathering fuels.
Performance data:	Thermal efficiency: 49%, turn-down ration of 2:1. Fuel to cook 5l: 516.6g. CO to cook 5l: 17.3g. PM to boil 5l: 786.6mg. (according to WBT 4.2.2, GERES, Cambodia, 2013).
Further information and ordering at:	Product specifications and user manuals at: http://www.primestoves.com/our-stoves/technical-documents



Photo 4.24
(Prime / Nurhuda)

4.2.8 ELSA stove assembly made of flat-packs

Available via three types of delivery:

- fully assembled units
- laser-cut flat sheets for import and local assembly
- as plans for construction for local production.



Photo 4.25
ELSA stove
(Blucomb)

Target area:	Developing countries.
Fuel type:	Pellets, woodchips, kernel, seeds, etc.
Designed by:	Carlo Ferrato, Davide Caregnato.
Retail price:	40–60 EUR (stainless steel AISI 316 laser-cut sheets).
Units sold:	100.
Start of production:	April 2013.
Manufactured by:	Blucomb S.r.l.
Contact:	info@blucomb.com
Address:	Via Aquileia ,70 - 33100 Udine (UD) ITALY.
Production capacity:	Scalable to demand.
Short description:	All-metal TLUD with detachable conical concentrator / riser, bottom raised by legs, micro-gasifier obtained by folded metal sheets.
Features:	Safe and ergonomic stay-cool handle.
Handling:	TLUD.
Char-making ability:	Yes.
Performance data:	From 1 kW up to 25 kW power size available.
Further info:	<ol style="list-style-type: none"> 1. Free plans and manuals at www.blucomb.com Custom-sized plans available upon request. 2. 300 stoves introduced in Ghana, Togo and Sierra Leone as a trial of the BeBi Project (http://www.bebiproject.org/info/research/development-of-a-new-stove), now the stoves are produced in these countries by independent artisans.

4.2.9 Aaron (Niger)

Target area:	Niger, Sahel region.
Fuel type:	Pelletised agricultural residues.
Designed by:	University of Turin, based on a design by the Brace Research Institute (Canada).
Retail price:	Not yet established, production cost is 16,000 FCFA (24 EUR).
Units sold:	270 produced, sale to start in 2014.
Start of production:	First prototype built in 2012.
Manufactured by:	Local tin-smiths in Niger in the regions of Niamey and Agadez.
Contact:	Stefano Bechis, University of Turin: stefano.bechis@unito.it Paolo Giglio Terresolidali, NGO: paologiglio@terresolidali.org
Address:	Terresolidali Niger, B.P. 10.388 Niamey, Niger. Source: Figures 4 and 9 from www.proener.unito.it
Production capacity:	1 per day by a skilled tin-smith; 15 artisans have been trained so far.
Short description:	Triple-walled natural-draft TLUD made of local metal sheets by local tin-smiths in an average Nigerian metal workshop. Height 550 mm, diameter 400 mm.
Features:	Pre-heated primary and secondary air entering at the top between the outer and the middle wall, flowing downwards. This cools the outer wall and increases temperatures inside the reactor. A 75 mm-high skirt of 340 mm in diameter increases heat transfer to the pot and can accommodate traditional round-bottom pots up to no. 5. The fuel container holds 1.2-1.4 kg of pellets made of residues from the staple crop millet, providing useful cooking energy for 90 minutes, sufficient to cook a typical meal for 6-7 people. Reduced risk of burns due to lower outside surface temperatures.
Handling:	The stove is top-loading and works as a top-lit batch stove. The external cylinder assures stability and protection from burn risks by touching. When a cooking cycle is finished, the char can be recovered by tilting the stove upside down using the handles.
Char-making ability:	Yes, when discharged after the flame is gone. If the material is left in the stove, it burns to ash within 6 to 7 hours, providing a temperature of about 120° C in the upper part of the stove.
User feedback:	The stove is easy and safe to operate; it does not generate smoke during normal operation, only when gasification comes to an end.
Performance data:	Aaron has been officially tested by the CNES (Centre National d'Energie Solaire). Results indicate 75% savings in biomass, compared to open fires, and 4.5 kW of maximum power, when used with pellets made of millet residues.
Further information:	http://www.energiesdurablesniger.org/biomasse.html and http://www.proener.unito.it/relazioni/rapport_fourneau_Aaron.pdf
Detailed report with drawings:	http://www.proener.unito.it/relazioni/rapport_fourneau_Aaron.pdf
Other comments:	Distribution of the stove is expected by the beginning of 2014, once a sufficient quantity of pellets made locally and of agricultural residues is available. This stove has been developed by the University of Turin (Italy) within the framework of an EU Energy Facility Project for sustainable energy. This project was implemented by a consortium led by the NGO Terresolidali based on a design from 1999 by the Brace Research Institute (Montréal, Canada). The full project reference is: European Commission 10th European Development Fund ref. 129-364 titled <i>Energies durables dans les regions d'Agadez et Tillabéri</i> CRIS n. 264 691.

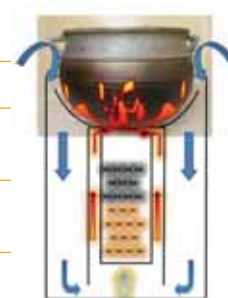

Photo 4.26
AARON stove

Source: http://www.proener.unito.it/relazioni/rapport_fourneau_Aaron.pdf



Photo 4.27
Aaron stove in Niger
(S. Bechis)

4.2.10 Estufa Finca Gen2 (Costa Rica)

Target area:	Central America.
Fuel type:	Wide variety of dry biomass: sticks, bamboo, coconut shell, cacao chaffe, etc.
Designed by:	Art Donnelly / SeaChar.
Retail price:	40USD*.
Units sold:	Over 700.
Start of production:	2010.
Manufactured by:	Community stove-building workshops.
Contact:	art.donnelly@seachar.org
Production capacity:	Limited, done by local artisans and women groups.
Short description:	The Estufa Finca (Farm Stove) is a TLUD-style micro-pyrolysis device with a capacity of 20l. As a batch-lit device, its typical burn time is 45 minutes. The basic stove is used as a burner in conjunction with a separate setting, which includes a cooking surface. Optional parts include a primary air-base, with a damper and a cook-top ring for portable cooking. Due to the large diameter of its fuel container, the stove is powerful and can reach 14 kW in its high power phase, equivalent to a 60l institutional stove. It is well suited for large families.
Handling:	Although typically used as a <i>batch</i> -loaded stove, it is possible to add input material at any time (while a flame is still burning). Though the body of the stove gets hot, the stove and the lid both have handles that remain safe to touch for the duration of use.
Char-making ability:	The biochar must be dumped out and quenched once the flame goes out. Depending on the material used, it yields 24-30% biochar (in weight from input material). The average yield per batch is between 0.75 and 1 kg of biochar.
User feedback:	Demand for the stove exceeds supply, and there is a waiting list of customers. However, fuel preparation and the short lifespan of the combustion chamber are still issues inhibiting further growth in demand.
Performance data:	Emissions testing by Aprovecho in 2010 came up with the following results: average CO: 8.24 g/kg dry fuel; PM: 0.18 g/kg dry fuel. This is a reduction of 83% in CO emissions and 91% in PM compared to an average 3-stone fire. CCT conducted in partnership with the University of Washington show 40-70% less wood used depending on the food cooked (rice, beans, chicken stew) compared to a traditional fogón (open fire).
Further info:	<ol style="list-style-type: none"> 1. SeaChar's current field work is the Estufa Finca Talamanca project. The project area is located in south-eastern Costa Rica on the Bribri Indigenous reserve. More information can be found on the website (www.seachar.org), SeaChar's YouTube channel or Facebook page. 2. Approximately 400 stoves have been produced for gardeners and enthusiasts in the United States. 3. Plans are available for free on request.



Photo 4.28
Migrant worker in Costa Rica using an Estufa Finca to cook food on the coffee farm (A. Donnelly)

4.2.11 SilverFire Hunter Chimney stove

Target area:	Worldwide.
Fuel type:	Chunky dry biomass.
Retail price:	149.95 USD in the US, cost for humanitarian projects can be negotiated down to < 50 USD.
Manufactured by:	Mass-produced in China by the Xunda Group, a large manufacturer of household appliances and stoves.
Contact:	Distributed by Todd Albi.
Address:	777 Washington Street Eugene, OR 9740, phone +1 541 222 9212 http://www.silverfire.us/page_11_15/silverfire-hunter
Production capacity:	Nearly unlimited.
Short description:	Portable, stainless TLUD stove with detachable chimney designed for both indoor and outdoor use; 30.5 cm square x 40.6 cm tall; ideal for worldwide shipping due to light weight of 6.6 kg. Double-boxed shipping carton: 9.54 kg, 35.6 cm x 45.7 cm.
Features:	The detachable chimney is a unique feature.
User feedback:	The ability to cook indoors under a shelter is a key advantage over stoves without a chimney.
Performance data:	Fire Power: ≥ 1.5 kW depending on primary air control, thermal efficiency: ≥ 35 % , PM ≤ 25 mg / m3 , SO2 ≤ 20 mg / m3 , NOx: ≤ 120 mg / m3 CO: ≤ 0.1 %.
Further information:	A chimney-less version with a attachable fan for forced convection is also available with the name <i>SilverFire Super Dragon</i> . See: http://www.silverfire.us/page_12_15/silverfire-super-dragon Humanitarian container orders can be placed with numerous stove options, and units can be shipped fully assembled or disassembled. Final assembly in some locations may decrease or eliminate duties and tariffs. See more at: http://www.silverfire.us/humanitarian



Photo 4.29
Getting ready
for installation
(SilverFire)

4.2.12 Sampada (India)

Target area:	India country-wide, export on request.
Fuel type:	The stove can use a wide variety of fuels such as hard wood, coconut fronds, coconut shells, ground nut or cashew nut shells, seeds of dates and similar fruit, dry twigs and leaf litter, biomass briquettes, etc.
Designed by:	AD Karve, ARTI.
Retail price:	2,150 INR (43 USD).
Units sold:	About 5,000.
Start of production:	2006.
Manufactured by:	Samuchit Enviro Tech Pvt. Ltd.
Contact:	Priyadarshini Karve, pkarve@samuchit.com or samuchit@samuchit.com
Address:	Flat No. 6, Ekta park Co-op Hsg. Soc., Behind Nirmitee Showroom, Law College Road, Erandwana, Pune-411004, Phone + 91 20 2546013, Fax + 91 20 25460138.
Production capacity:	Stoves are produced to order.
Short description:	Portable, natural-draft TLUD with stainless-steel outer body, mild steel fuel chamber, diameter 15 cm, height 28 cm, weight 1.5 kg. Low-power stove for light cooking tasks such as making tea, snacks, boiling / heating water, etc.
Handling:	The stove can be used in top-lit up-draft or bottom-lit up-draft mode. One full charge of fuel keeps the stove in operation for about 1 hour. Fuel can be added for longer durations of continuous cooking.
Char-making ability:	Makes high quality charcoal that can easily be saved since the stove is light-weight and has handles. 1 kg of wood yields around 200 g of charcoal. The special feature of this stove is that when hard wood is used as fuel, charcoal is produced as a by-product of cooking, which can be a source of additional income.
User feedback:	Clean cooking while making charcoal; fuel efficient and cheap to operate; a source of additional income, as the charcoal produced has a higher value than the original wood fuel; more demand for the char-making ability from biochar users in Europe at present.
Performance data:	Emissions to cook 2.5l of food: 8.1mg CO, 69mg PM. Results from US EPA: Time to boil 5 l is water 21 minutes, thermal efficiency 27.6%, firepower 3.7-5.2kW. More details at: http://catalog.cleancookstoves.org/#/test-results/431 . Further information: http://www.samuchit.com/clean-cooking-devices-h/26-sampada-gasifier-stove.html Samuchit products are now available in Europe via: www.sampada.de or http://www.sampada.de



Photo 4.30
Flame pattern in the Sampada as seen from above (Samuchit)

4.2.13 Vesto - variable energy stove (Swaziland)

Photo 4.31
Vesto
(Newdawn)

Target area:	Worldwide.
Fuel type:	Designed for all biomass including split hardwood, sawdust briquettes, charcoal, branches and chunky biomass less than 180 mm long; the device can burn wood, dung and pellets in TLUD mode (from wood, switchgrass and others).
Designed by:	Crispin Pemberton-Pigott.
Retail price:	440 ZAR (45 EUR), including accessories. Barbecue plate + support stand available separately.
Units sold:	Over 4,000.
Start of production:	2004.
Manufactured by:	New Dawn Engineering Swaziland / Gambia.
Contact:	Thabsile Shongwe, thabsile.s@newdawnengineering.com sales@newdawnengineering.com or support@newdawnengineering.com
Address:	P.O. Box 3223 Manzini, MZ200, Swaziland + 268 518 5016 or 518 4194.
Production:	100 / day (upon order).
Short description:	Natural-draft stove with incorporated pot-skirt based on a 25 l paint can. Diameter 300 mm, height 440 mm, weight 4.5 kg without accessories, 7 kg with accessories, boxed. Power output of 4 kW depending on air regulation. Best suited for pots of < 270 mm in diameter so that the pot can be sunken into the skirt – larger pots, woks and frying pans can also be used. Stove body has a wire handle; removable, perforated fire chamber with a replaceable grate at the bottom; stainless steel pot supports.
Features:	Controlled air supply of pre-heated primary air as well as pre-heated secondary air. Designed for rapid fire development (start cooking in 1 minute after ignition); replaceable consumable parts (modular design).
Handling:	It can be used as bottom-lit continuous-feed stove or batch-fed TLUD. Cooking time is typically 20-40 minutes without attention; when correctly loaded with dense hardwood, up to 1 hour. Light biomass requires more frequent refuelling. It can accommodate fuel from twigs of up to 110 mm in diameter and also wood, preferably 200 mm or less in length (over-filling a wood stove blocks proper air flow and creates a smoky burn).
Char-making:	Only in pyrolytic TLUD mode with restricted primary air supply.
User feedback:	Fast, little smoke, economic and fuel efficient especially with pot that can be sunken in the skirt; inconvenience of having to remove pot entirely for refuelling as the pot skirt prevents refuelling with pot inside.
Performance data:	Sunken pots: wood fuelled: 25-35 % efficient; charcoal fuelled 35-55 %; heat can be partly controlled by a combination of fuel and air metering; fuel savings of 70 % compared to open fire (typical). The Vesto was tested in the 2013 round of EPA lab tests (Jim Jetter) but the results have not yet been published. Further information: http://www.newdawnengineering.com/website/stove/singlestove/vesto
Other comments:	The Vesto was developed as a mass-produced product though components can be incorporated into artisanal products in villages. It can burn extremely hard wood. It won the DISA Chairman’s Award and Housewares Division, (South African Design Excellence Awards 2004) and received a Merit Award from the Stainless Steel Manufacturer’s Association (2004) for innovative use of stainless steel. Production has commenced in the Gambia (2013) on a limited scale (500).



4.2.14 Anglo Supra Nova (Indonesia)

Target area:	Indonesia.
Fuel type:	Fuel-flexible: Chunky biomass, wood, wood chips or biomass pellets in TLUD mode, charcoal in bottom-burning up-draft mode.
Designed by:	C. Pemberton-Pigott and Yayasan Dian Desa.
Retail price:	5.50 USD.
Units sold:	< 500.
Start of production:	2013.
Manufactured by:	Various artisans in Yogyakarta.
Contact:	crispinpigott@gmail.com
Production capacity:	Just started, but scalable.
Short description:	The stove evolved from a charcoal stove that can also burn raw biomass in TLUD-mode. It has a terracotta body in a metal shell, handles for portability and a removable clay grate. It offers a choice of various combustion chamber sizes.
Features:	The combustion chamber can be made removable so that various sizes and depths can be inserted. This controls the firepower (diameter) and the duration of the burn (depth). It has a fixed pre-heated secondary air supply and a fully controllable primary air supply via a lower control door – a loose piece of clay serves as a door that can close off primary air without affecting secondary air. It provides a significant level of power control without adding or removing fuel.
Char-making ability:	In TLUD mode, the stove can act as a pyrolyser (making char); the char can then be saved or the stove can automatically switch to char-burning in BBUD mode after pyrolysis is complete by using a paper air controller that burns away at the appropriate time, changing the airflow to increase primary air necessary for char-burning.
Performance data:	Heat-transfer efficiency when burning charcoal (it is a charcoal stove) is about 50%. Power is 1-6 kW.
Further information:	The stove evolved in various steps from the Thai bucket, Anglo (ang-lo), Anglo Supra to the Anglo Supra Nova (ASN): http://stoves.bioenergylists.org/content/stoves/anglo-supra-nova
Other comments:	The secondary air supply method has been copied by SNV (Netherlands) with positive results and introduced in Laos and possibly Cambodia.



Photo 4.32
(C. Pemberton-Pigott)

4.3 Catalogue of TChar combinations for chunky biomass

This section lists models that can burn char and consist of two functional parts: a gasifier component on top of a charcoal-burner.

4.3.1 Malaika Jiko (Kenya)

Target area:	Kenyan charcoal users.
Fuel type:	Chunky wood or other biomass.
Designed by:	Nathan Puffer (US).
Retail price:	2,500 KSH (28 USD).
Units sold:	854.
Start of production:	March 2012.
Manufactured by:	Wisdom Innovations.
Contact:	+254 723 241907.
Address:	P.O. Box 271, North Kinangop.
Production capacity:	30 / week.
Short description:	TLUD accessory that can be used with commonly available charcoal stoves in Kenya allowing users to make their own char instead of buying it. Follows the TChar concept, but can be attached to existing stoves.
Features:	Two separate functional parts: gasifier top, charcoal-burning bottom..
Handling:	See <i>Figure 4.1</i> for details. Further explanations can also be found in the user manual at: http://www.wisdomstoves.org/ourstove.html#jiko . Easy transport, has its own packaging.
Char-making ability:	Produces charcoal from chunky wood or other biomass while cooking.
User feedback:	Easy and quick to light, very clean flame, stable; a lot of positive feedback from the current users; some negative feedback due to its short lifespan when not properly used.
Performance data:	Performs very well when the wood is dry.
Further info:	This model is an improvement on a previous version of the Malaika stove. The secondary air door has been replaced with secondary air-holes at the bottom of the outer cowling. Links to videos showing the assembly and operation of a Malaika Jiko at: http://www.wisdomstoves.org
Other comments:	Wisdom Stove has recently started to commercialise a complete <i>all-in-one</i> TChar stove model M2 with TLUD top and ceramic insert for continuous cooking after char formation. Cost: 3,800 KSH (43 USD).



Photo 4.33
Two-storey Malaika Jiko (N. Puffer)

Figure 4.1 Handling of the Malaika

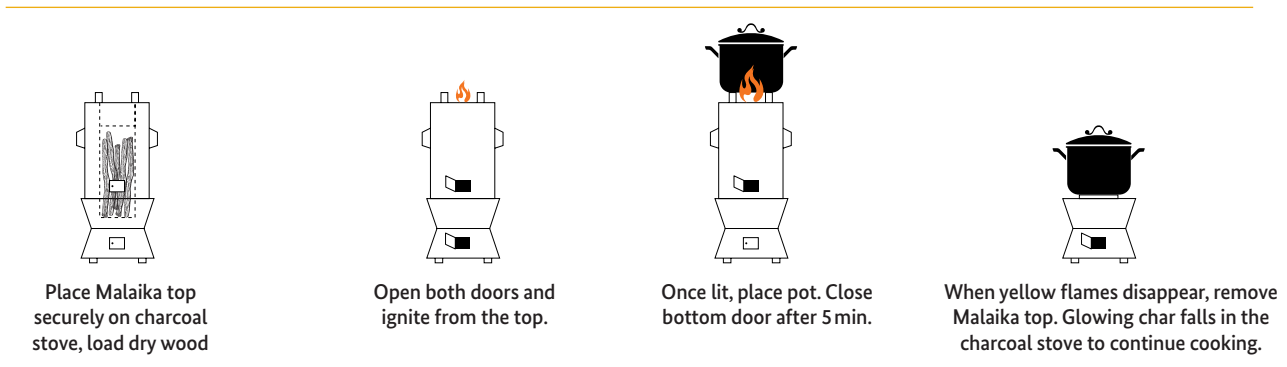

4.3.2 Jiko Bomba - the best stove (Tanzania)

Target area:	Tanzania.
Fuel type:	Pellets made of agricultural residues (mainly rice husk).
Designed by:	Bjarne Laustsen.
Retail price:	24,000 TZS (15 USD).
Units sold:	4,200.
Start of production:	August 2011.
Manufactured by:	Kiwi & Laustsen Limited.
Contact:	Director Bjarne Laustsen, bjarne@kiwila.com
Address:	P.O. Box 285, Karatu, Tanzania http://www.kiwila.com
Production capacity:	480 / month.
Short description:	Double-walled, locally produced TLUD-ND made of mild steel, optimised for pellets composed of mixtures of agricultural residues as a fuel. Diameter 23 cm, height 37 cm.
Features:	The stove is composed of two vertically stacked assemblies: the bottom part is the stove unit comprising of a fuel reactor and a primary air regulator. The top part comprises of a mixing chamber, an internal chimney space and pot-rests. Its perforated bottom plate enhances pre-mixing of wood-gas and oxygen before ignition in order to achieve clean combustion. Both assemblies have handles and pot-rests.
Handling:	Top-loaded.
Char-making ability:	Yes, but char can also be utilised to continue cooking on the bottom unit after the end of fuel pyrolysis.
User feedback:	Women appreciated reduced eye-irritations due to less smoke, especially since women with red eyes in this region are often accused of witchcraft.
Further information, photos and details at:	http://stoves.bioenergylists.org/node/3142 http://dhe12s.blogspot.de/2012/05/meeting-with-partners-for-development.html http://www.youtube.com/watch?v=jH_kI4EuH9k
Other comments:	The two-storey stove is similar to the TChar concepts described at: http://www.drtilud.com/2012/08/02/tchar-tech-paper-series



Photo 4.34
Jiko Bomba - the best stove (Tanzania) (Laustsen)



Photos 4.35 - 4.37
Jiko Bomba in various stages (Bjarne Laustsen)

4.3.3 Butembo TChar gasifier (DR Congo)

Photo 4.38
Butembo TChar
gasifier (A. Vwambale)

Target area:	Central Africa.
Fuel type:	Firewood or other uncarbonised biomass.
Designed by:	Christa Roth and Anselme Vwambale.
Retail price:	15 to 25 USD.
Units sold:	100 stoves.
Start of production:	April 2012.
Manufactured by:	ADIFANOKI.
Contact:	E-mail: musoest@yahoo.fr Skype: anselme.vwambale. Tel: +243997090840 or +243 810756006.
Address:	Ndonga 43, Matanda Quarter, Butembo Town, Province of North-Kivu, Democratic Republic of Congo.
Production capacity:	14 / month, can be scaled-up if needed.
Short description:	This is an all-metal <i>double-decker</i> TChar stove with a 14 cm inner diameter for the fire chamber and a total height of 34 cm (18 cm for the bottom charcoal unit, 16 cm for the upper gasification unit). In its high-power phase, the firewood or any granular uncarbonised biomass is pyrolysed and the gases that are burnt provide high heat to a pot placed on top. Once the biomass is converted into char and the volume reduced by half, the pot is temporarily lifted off, and the top-part of the TChar removed.
Features:	The stove has two parts: a TLUD gasifier unit on top of a double-walled charcoal stove unit. The bottom charcoal burner has a door for primary air control and separate secondary air holes. The inner sleeve of the gasifier unit slides into the bottom unit, preventing it from moving sideways. This has the advantage of providing more stability and also blocking the secondary air holes of the charcoal burner. Both units have handles and pot-rests.
Handling:	Hot char automatically falls into the charcoal burner below. This eliminates the need for overturning the stove when transferring the hot embers into another vessel, either for quenching or to continue cooking. This is a much safer procedure and prevents accidents. The pot can then be placed on the bottom unit and the heat of the hot char used for the low-power phase such as simmering. Opening or closing the door of the bottom unit, which regulates the primary air supply to the hot charcoal-bed, can control the heat-output. This feature provides the turn-down ratio that many pure gasifiers lack. Can accommodate 5 l pots, but it is not recommended to do any heavy stirring on the upper unit unless extra legs are added. Stirring of local maize-pap is normally done during the simmering phase and on the lower unit.
Char-making ability:	15-20% of the mass of the fuel used (depending on the kind of fuel and air control), and the TChar feature allows the user to decide whether to save the char for later use or to keep cooking with it while it is still hot.



User feedback: Uses less fuel than an open fire, reducing the cost and time of fuel collection; provides instant strong and fast fire which does not need attention for refuelling during the high-power phase; emits very little smoke; produced charcoal can be used on the same stove and is easy to use. In Butembo, firewood vendors have started to supply ready-cut firewood for the Butembo TChar.

Performance data: Thermal efficiency for the charcoal stove unit: 44.3% (IWA tier 4), overall efficiency for the TChar: 23.8%. In a controlled cooking test, a meal was cooked in 90 minutes with only 0.5 kg of wood, including burning the char in the simmering phase.

Further information: The bottom unit of the charcoal stove won the *Kirk Smith Cat Pee Award* during the Aprovecho Stove Camp in 2012.
<http://www.aprovecho.org/lab/work/conferences/stove-camp/13/99-stove-camp-2012-outline>

Reports from the field: Dekiwe Munemo (Malawi):

My family uses the TChar to heat bathwater. The boys have learnt how to prepare the fuel and ignite it. They like it because now they can have warm water for their bath when they come back from school. I also like the fact that I don't have to constantly add fuel. This frees up a lot of my time, so I can afford to invite my friends to come over to chat while I am cooking. They don't mind sitting around the stove with me as there is hardly any smoke.



Photos 4.39 -4.41

4.4 Catalogue of fan-assisted stoves for chunky biomass

Fan-assisted stoves typically have very low emissions and provide a high level of convenience to the user; however, the fan comes at a price.

4.4.1 Philips HD4012 gasifier cookstove

Target area:	Philips has re-started production of the HD4012 cook stove in Africa, which had previously been built in small numbers in India. Interest is high, and Philips is currently exporting across Sub-Saharan Africa and is taking enquiries globally.
Fuel type:	Twigs and small wood pieces, wood pellets and briquettes, dung and other dry biomass.
Designed by:	Philips.
Retail price:	72 USD.
Units sold:	15,000.
Start of production:	December 2012.
Manufactured by:	African Clean Energy (ACE), distributed by Philips.
Contact:	Mark Bennett, mark.bennett@philips.com , +31 610 70 9635.
Address:	Philips South Africa (Pty) Ltd., P.O. Box: 58088, Newville 2114, South Africa.
Production capacity:	50,000 / year and growing.
Short description:	A high efficiency TLUD gasifier stove with forced air. It has a stainless-steel construction, the inner combustion chamber is ceramic. The stove is virtually smokeless due to a good air-gas mixture for complete combustion that is created by the fan at the bottom of the combustion chamber. The battery can be charged either from the grid, if available, or using a solar charger. Power output is adjustable up to ± 5 kW by simply turning a knob.
Features:	Fan speed control allows for fire adjustment for tasks from simmering to boiling. Expected lifespan of 5 years. Models that are tuned for wood / twigs and pellets also available.
Handling:	The stove is top-loading and requires small pieces of wood or other chunky biomass. It can be operated as bottom-lit continuous-feed or top-lit batch-fed stove. If used as top-lit batch-fed stove, it should not be filled to more than half. The stove can be refuelled during use.
Char-making ability:	Char burns to ash in standard mode due to efficient burning but can be adjusted to leave char residue.
User feedback:	An aspirational product; convenient in terms of speed, clean cooking, portability to allow for cooking outside; saves costs by increased fuel efficiency and wood has a lower cost than charcoal, LPG or kerosene; appealing design and attractive alternative to other fuels; robust, promises a long lifespan; good turn-down of heat due to fan speed control.
Performance data:	Lowest CO and PM2.5 ratings tested by the US EPA: Sub-tier 4 for high and low-power CO, Sub-tier 3 for PM. IWA high power CO 0.98-2.71 g / MJ del, PM 62.3-147.3 mg / MJ del. IWA low power CO 0.01-0.03 g / min / l, PM 0.55-0.66 mg / min / l. Time to boil 17.5 minutes, firepower between 1.7-5.2 kW, thermal efficiency 36-42%. Source: http://catalog.cleancookstoves.org/#/stoves/47 Compared to open fires, CO and smoke is reduced by over 90%; up to 65% reduction in fuel use. The full report by the USEPA can be accessed at: http://ehs.sph.berkeley.edu/krsmith/?p=1387



Photo 4.42 (Philips)

Further information: http://www.pciaonline.org/files/Stoves_Paper_Final_Color_2.26.09.pdf shows results for the previous model HD 4010 with a thermo-electric generator. The report on user feedback by Kirk Smith et al. *Cooking with gas*: a copy for non-commercial research and education use can be accessed at: <http://ehs.sph.berkeley.edu/krsmith/?p=960>

Other comments: Photo of stove being tested at the US EPA laboratory on page 7 of: <http://www.vrac.iastate.edu/ethos/files/ethos2013/Room%202/Sunday%20AM/Update%20on%20U.S.%20EPA%20Research%20Activities.pdf>
The stove is being promoted in many African countries, e.g. with co-operation partners in Rwanda (Inyenyeri), Zambia (Emerging Solutions) etc. In Malawi the Liverpool School of Tropical Medicine is carrying out a study on health impacts with this stove. More information available at: <http://capstudy.org>
The Natural Draft Philips gasifier stove 4008 is no longer being commercialised.

Photo 4.43
Manufacturing
in Lesotho
(Alice Troostwijk,
African Clean Energy)

Photo 4.44
Inset: Happy users
in Rwanda
(Allie Gates, Inyenyeri)



4.4.2 TERI SPT_0610 design

Target area:	India, expanding to Africa (so far Kenya, Ethiopia).	
Fuel type:	Any dry biomass like wood, agricultural residues, dry cattle dung.	
Designed by:	The Energy and Resources Institute India (TERI).	
Retail price:	Up to 100 USD in India (depending on subsidies).	
Units sold:	Over 2,500.	
Start of production:	2011.	
Manufactured by:	Local partners.	
Contact:	J. Murali Ph.D Fellow & Area Convenor Rural and Renewable Energy Area, Bangalore, J.Murali@teri.res.in	
Address:	The Energy and Resources Institute Southern Regional Centre 4 th Main 2 nd Cross, Domlur Bangalore - 560 071 Phone +91 80 2535 6590. www.teriin.org	
Production capacity:	Scalable.	
Short description:	Fan-assisted stainless steel stove for one pot.	
Features:	Power charger has a dual charging mode (both AC / grid power supply and solar power supply) to cater to households in un-electrified areas, batteries 11.1V, 2.2 Ah lithium cobalt oxide.	
Handling:	Top-loading, top-lit. Once some char has formed at the bottom, the fan allows for continuous refuelling and operation in bottom-burning mode.	
Char-making ability:	Poor: Char is consumed if fan is used after the end of pyrolysis.	
User feedback:	Stove can use readily available and inexpensive fuel; up to 50% less fuel use, less smoke, less soot on pots and walls.	
Performance data:	Indian Institute of Technology, Delhi (IIT-D): 37% thermal efficiency, CO 2.25 mg / MJ del, PM 147 mg / MJ del, power output 1.08 kW.	
Further info:	<ol style="list-style-type: none"> 1. General info at: http://www.teriin.org/technology/stove-writeup.php 2. Stove appears in <i>Vandanas</i> story: http://www.youtube.com/watch?v=KMNnmv4zGnc 3. Performance evaluation of three types of forced-draft cook stoves using fuel-wood and coconut shells: http://www.sciencedirect.com/science/article/pii/S0961953412005260 4. Real-Time Assessment of Black Carbon Pollution in Indian Households Due to Traditional and Improved Biomass Cookstoves: http://blogs.washplus.org/iaqupdates/2012/03/real-time-assessment-of-black-carbon-pollution-in-indian-households 	
Other comments:	Interested manufacturers can be granted access to the TERI design upon request and become a licensed manufacturing partner.	

Photos 4.45 - 4.46 (TERI)

4.4.3 SilverFire Dragon stove

Target area:	Worldwide.
Fuel type:	Chunky dry biomass.
Retail price:	169.95 USD in the US.
Manufactured by:	Mass-produced by Xunda in China.
Contact:	Distributed by Todd Albi.
Address:	777 Washington Street Eugene, OR 9740, phone +1 541 222 9212. http://www.silverfire.us/page_12_15/silverfire-super-dragon
Production capacity:	Nearly unlimited.
Short description:	Portable stainless TLUD stove with fan, 30.5 cm square x 40.6 cm tall; due to light weight of 7.6 kg, it is ideal for worldwide shipping. Shipping carton: weight 10.45 kg, 35.6 cm x 45.7 cm.
Features:	12V DC fan (with AC adapters or 13 W solar panel) can adjust speed to regulate firepower of stove; very convenient for simmering.
User feedback:	Fast and powerful stove; good turn-down of power due to adjustable fan speed.
Performance data:	Fire Power: ≥ 1.5 kW depending on primary air control; thermal efficiency: $\geq 35\%$, PM ≤ 25 mg / m ³ , SO ₂ ≤ 20 mg / m ³ , NO _x : ≤ 120 mg / m ³ , CO: $\leq 0.1\%$.
Further information:	For a natural-draft version with detachable chimney: http://www.silverfire.us/page_11_15/silverfire-hunter



Photo 4.47
(SilverFire)

4.5 Catalogue of natural draft stoves for rice husks

“Since rice husk is perhaps the largest potential domestic fuel source in a desperate world it is likely that survival will be chosen over potential health risks. We can’t abandon rice husk as a fuel. We have to find ways to make it work. TLUDs may be part of the answer.”

Tom Miles (bioenergylist 2013)

Rice husks are an important source of fuel, with the annual world supply estimated to exceed 115 million metric tonnes. Due to its small particle sizes, low bulk density and high ash content, this fuel requires special burner designs and functions best with the assistance of a fan. Extra categories have been created in the catalogue for natural-draft and fan-assisted stoves for rice husks for this reason.

People concerned about dangerous cristobalite formation were advised that these are less likely to form at lower temperatures and during shorter usage times in a gasifier than in a direct flame.

There are various types of natural-draft stoves with a conical fuel hopper for rice husk, like the LoTrau stove in Vietnam. The advantage of these designs is that they do not require electricity and allow for continuous feeding – also referred to as *quasi* or *semi* gasifiers. The downside is that they need constant attention and a good bit of experience

to operate: the flowability of rice husk is poor, so it is necessary to tap the stove frequently every 5 to 10 minutes to keep the fuel feeding the burner and to prevent the fire from going out. Tapping it too hard, however, can cause the rice hulls to spill out of the bottom and disrupt the cone of coals.

The stoves are much shorter than the rather tall and top-heavy TLUD rice husk gasifiers and a promising option for areas where stove height might be a barrier for cultural acceptance. It is also ideal for areas where electricity access is a challenge and purchasing power demands low-cost options. Countless tin-smiths in many Asian countries manufacture these stoves. In India, Navdurga Metal Industries NDMI mass-produces them under the name Janta Chulha. They have sold over 10,000 units since 2010. Find more information at: <http://ndmigroup.com/Agni%20Janta%20Chulha.html>

Photo 4.48
Artisanal LoTrau-type stove from Vietnam

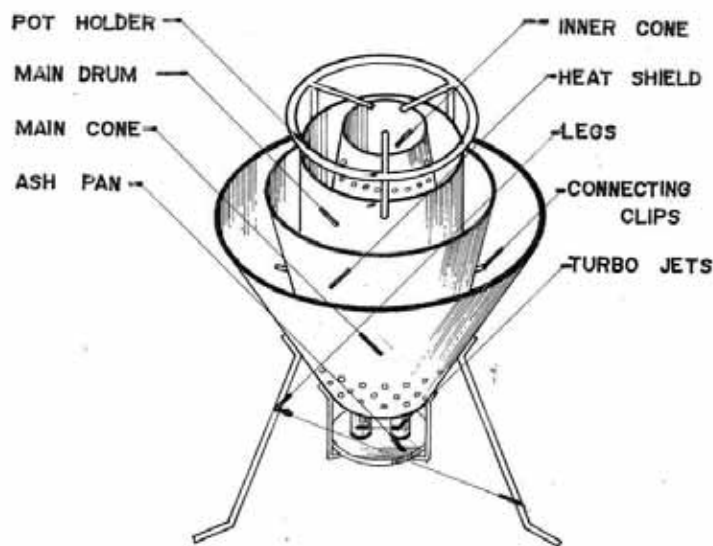

Photo 4.49
Mass-produced stove from NDMI in India



The LoTrau stove served as the basis for the development of the Mayon Turbo Stove and other so called *quasi gasifiers*. The Mayon Turbo is presented here as the only model of this kind that was tested by the US EPA.

Figure 4.2 Drawing of the Mayon Turbo Stove



4.5.1 Mayon Turbo Stove (Philippines / Gambia / Senegal)

Target area:	Currently promoted by REAP in the Philippines, Senegal and the Gambia.	
Fuel type:	Rice husk as well as peanut shell and other shells and husks.	
Designed by:	Developed by REAP Canada, based on LoTrau design from Vietnam.	
Retail price:	15-20 USD.	
Units sold:	Over 5,000 in the Philippines, over 2,000 in the Gambia and Senegal.	
Start of production:	2001.	
Manufactured by:	Local artisans.	
Contact:	Roger Samson, info@reap-canada.com	
Production capacity:	In order to encourage increased stove production around the world, REAP Canada has prepared an International Marketing and Manufacturing Package which includes information on the resources needed to manufacture and disseminate the stove at the local level. It includes general information on the stove, design drawings for manufacture, an instruction manual, brochures, and former case studies; it can be obtained for 200 CAD from REAP.	
Short description:	Top-lit continuous-feed natural-draft gasifier; dimensions depend on model: 165 or 178 mm diameter, weight 4-5 kg. Made of sheet metal and steel by local artisans.	
Features:	Conical fuel hopper that is open on top, combustion chamber in the centre of the hopper; primary air drawn through 3 rows of holes in the hopper; secondary air drawn above the fuel-bed through twin pipes in the ash pan and holes in the centre cone. Secondary air provides turbulence to enhance combustion. Excess air is limited by the low porosity of rice hulls.	
Handling:	Can continuously be fed from the open top of the conical hopper. Tapping to introduce new fuel to the combustion chamber in the centre of the hopper is required every 3-5 minutes.	
Char-making ability:	Depending on how frequently fuel is fed through by the user, rice hulls can produce char or can be burnt down to a grey ash. Rice hull ash is commonly used as a fertilizer and pest repellent.	
User feedback:	Fast starting; very economical to operate; enables considerable savings; clean burning of rice hull; more tedious than wood cooking due to tapping; good pot stability; uses a wide range of inexpensive fuels.	
Performance data:	Test results from US EPA: http://catalog.cleancookstoves.org/#/test-results/408 IWA high power CO 13 g / MJ del, PM 443 mg / MJ del. IWA low power CO 0.14 g / min / l, PM 8.37 mg / min / l. Time to boil 5 l of water: 32 minutes; firepower between 3.2-4.1 kW; thermal efficiency 28%. According to a 2005 Report done by Aprovecho. (http://www.reap-canada.com/library.htm#mts) 1 l of water can boil in 6-7 minutes.	
Further information:	http://www.reap-canada.com/bio_and_climate_3_3_1.htm http://www.reap-canada.com/online_library/IntDev/id_mts/30-Sustainable%20Household.pdf http://www.hedon.info/View+Stove?itemId=8957	
Other comments:	The stove was developed along with local artisans in the Philippines in 2001. It was introduced in the Gambia in 2003, and it is now also produced in Kaolack, Senegal.	

Photo 4.50
Mayon Turbo Stove
running on
cacao waste

4.5.2 mlc – my little cook stove (Chad, Cameroon)

Target area:	Mwea region (Kenya), Logone Valley (Chad and Cameroon).	
Fuel type:	Rice husk.	
Designed by:	Simone Pietro Parmigiani and Francesco Vitali.	
Retail price:	5-10 EUR.	
Units sold:	Over 100, current number unknown.	
Start of production:	July 2013.	
Manufactured by:	Local artisans.	
Contact:	francesco.vitali@ing.unibs.it Via Branze 43, 25123 Brescia (Italy).	
Production capacity:	Unknown. Each trained artisan can build up to 5 / day.	
Short description:	Low-cost, natural-draft, fixed, mud-brick stove with a chimney that creates draft and guarantees the withdrawal of smoke from the cooking environment. An internal metal-net reactor holds the biomass in the combustion chamber. Such a layout allows for a mixture of combustion / gasification of biomass that is suitable for cooking tasks.	
Features:	First known stove for rice husk fuel with natural draft via a chimney. Bi-cylindrical basket reactor to hold the rice-husk fuel. Primary and secondary air inlets from the open bottom part; draft can be regulated through a butterfly valve on the chimney.	
Handling:	Batch-feed stove. The reactor is filled with rice husk and then placed in the combustion chamber. Lighting with small amount of charcoal or other ignition material placed in the inner duct to start.	
Char-making ability:	Rice husk char is produced at the end of the process (about 25 % of the weight of the initial fuel charge) for use as biochar in fields.	
User feedback:	Advantages: Economic savings (up to 80 % of the daily cooking expenditure), heat is retained by the stove structure and can be used for other purposes (i.e. water heating for washing in the morning after cooking the evening before); batch solution (suitable for long cooking times, not for short preparation, i.e. coffee, tea); Disadvantages: Unfamiliar handling compared to wood use implies a shift in traditional firing practices (sometimes hard for elderly women).	
Performance data:	WBT efficiency* 18 %, Time to boil 5 l of water is 27 minutes; total duration of one full load is 57 minutes. Specific consumption 331 g / kg, 4,152 kJ / kg. Burning rate, 18 g / min; mean power 4.1 kW. CCT (rice): Duration: 45 minutes; fuel consumption: 0.33 kg rice husk / kg cooked food Indoor Air Pollution: No significant CO or PM increase in the testing room during stove use.	
Further reading:	<ul style="list-style-type: none"> • The Right chimney for rice husk, a bilingual leaflet on the mlc at: http://issuu.com/paolarosa/docs/la_mlc_di_vitali_parmigiani • Link to the Italian instruction manual and other publications at: http://fuocoperfetto.altervista.org/la-mlc-di-vitali-parmigiani.html Under this link you can also find the following PhD theses: • Vitali, F: Appropriate solutions for cooking energy at household level in the Logone Valley (Chad-Cameroon), University of Brescia 2011. • Parmigiani, S: Appropriate technologies for an emancipating cooperation: The development of an effective improved cook-stove, University of Brescia 2011 • Design and performance assessment of a rice husk-fuelled stove for household cooking in a typical Sub Saharan setting. Authors: Simone Pietro Parmigiani, Francesco Vitali, Adriano Maria Lezzi, Mentore Vaccari. Under review by Energy for Sustainable Development. 	
Other comments:	This prototype was designed according to the typical rural socio-technical constraints of the Logone Valley (Chad / Cameroon) and is now under review in a pilot study in Kenya (about 35 stove households).	

Photo 4.51
Views of the mlc
(F. Vitali)

4.5.3 DK-T3* (Vietnam)

Target area:	Northern Vietnam.
Fuel type:	All types of dry small biomass combined with stick-shaped firewood.
Designed by:	Do Duc Khoi.
Retail price:	20 USD.
Units sold:	600.
Start of production:	2013.
Manufactured by:	PED Factory.
Contact:	Mr. Do Duc Khoi – Director of Population, Environment and Development Centre (PED) pethanoi@fpt.vn or khoi.ped.hn@gmail.com
Address:	No 58, Lane 162, Nguyen Van Cu str. Bo De, Long Bien, Ha Noi Mob +84 913 540 129; Fax: +84 4 3872 4508; Tel: +84 4 3872 4509.
Short description:	Double-chamber hybrid design that does not directly gasify the rice husk, but rather uses heat created by another fuel source to pyrolyse the husks (allothermal gasification). Cylindrical stove designed to make char from small biomass like rice husk, corn cobs, grass, wood shavings, sawdust, coconut shells, or coffee shells using natural draft and eliminating the need for a fan. Top cover including pot-rests. Dimensions: 30 cm diameter, 40 cm high, weight 4.5 kg, door 7 x 9 cm. Manufactured with modern machinery using high-quality steel and heat-resistant materials, creating a very strong and durable product.
Features:	Does not need electricity or a fan. The stove has two main parts: an L-shaped rocket-elbow of 9 cm in diameter doubling as a chimney passes through a larger cylinder filled with rice husk or other small biomass. This adds insulation to the perforated rocket-elbow that can be fired with stick-shaped, small firewood or bamboo. The fire inside of the chimney generates heat, which in turn transforms the biomass in the outer cylinder into char, starting from the centre outwards. The gases created in the process are sucked into the inner chimney through the holes and combusted along with the flames from the firewood. The result is more intense heat and very clean combustion. Apart from during the lighting phase, there is no smoke, not even from the firewood. The small biomass in the outer cylinder also adds insulation to the perforated rocket-elbow.
Handling:	Continuous cooking with firewood pushed into the rocket elbow. Once the biomass in the outer cylinder is charred, the char can be emptied or cooking can continue with the firewood until the meal is ready.
Char-making ability:	Inner chamber can hold 1.2 kg of rice husk/biomass; 350-400 g biochar left after 40 minutes of cooking.
User feedback:	Positive feedback: Users appreciate that it is affordable, cooks quickly and allows them to use many kinds of biomass fuels, so they reduce the need to purchase firewood. It is very easy to use and creates very little smoke and dust. As it does not need an electric fan, they are not bound to a socket but flexible in where they use the stove. Users were instructed on how to use biochar and make microbial organic fertiliser. Negative feedback: Not suitable for large pieces of wood; durability not yet known.
Performance data:	28-30% thermal efficiency, time to boil 5 l of water is 13-15 minutes. The outer chamber is filled to capacity with small biomass, a cover is placed on the stove and the fire lit at the centre. After a short time, the rice husk pyrolyses and adds to the burnable gas.



Photo 4.52
DK-T3*
(Do Duc Khoi)



Empty stove



Cover of centre hole during loading



Filled to capacity with rice husk



Fire is started with wood logs



Flame additionally fuelled with gas from rice husk

Photos 4.53 - 4.57
DK-T3* in operation

4.6 Catalogue of fan-assisted stoves for rice husk



Photo 4.58
Double-walled rice husk burner from Belonio (without burner head)

It had been regarded as impossible to gasify rice husk in small TLUDs until Prof. Alexis Belonio from the Philippines proved otherwise. The first model conceptualised by Alexis Belonio has been overhauled and is now manufactured in its 2nd generation in the Philippines, and over 3,000 units have been sold since 2006. Prof. Belonio was awarded the prestigious Rolex Award in 2008 for his efforts in making rice husk fuels usable as a clean energy source. One of his merits is the design of the unique burner head that permits for pre-heated secondary air supply in a single-walled unit. Several commercial rice-husk gas burners are now based on his concept. They are all top-loaded, top-lit with the up-draft assisted by a fan that requires an external power source.

The bottom of the reactor is sealed except for the entry point for primary air, which is pushed in by a fan attached outside. The detachable burner can act as a pot-support, or the pot can be placed on an outside structure, e.g. an enclosure for the reactor. Reactors either have a single or a double wall. The pyrolysis front is ignited at the top of the fuel in the reactor, and the stove-top with the burner head is placed on top. The gas that is formed exits the reactor through the holes in the stove top with the help of forced convection via the fan at the bottom. Ambient air rises through the gap between the double walls or along the outside (for a single wall reactor). It picks up heat from the reactor and exits through the upper side-holes. On account of the stove's clever design, the pre-heated air clings to the metal and is naturally drawn towards the combustible gas, which only ignites and combusts outside when sufficient oxygen is available.

Since its inception, a number of commercially available stoves that are based on Mr. Belonio's ideas have been developed.

Further reading on rice husk stoves

- Information on many more rice-husk burning designs developed by Alexis Belonio can be obtained from the Centre for Rice Husk Energy Technology in Iloilo, the Philippines. Have a look at the dual-reactor and continuous-flow rice husk gasifiers for restaurants and home industries:
<http://energymap-scu.org/center-for-rice-husk-energy-technology/>
- A very comprehensive training manual featuring construction and marketing options, testing reports and detailed plans for rice husk gas stoves: <http://stoves.bioenergylists.org/beloniohandbook>. The site includes learning modules about the underlying principles and the development of the technology. A video on Vietnam magic flame stoves can be found at:
<http://www.youtube.com/watch?v=5juuitxuWVU&feature=related>
- The continuous-feed gasifier demonstrated at <http://www.youtube.com/watch?v=xQGS-VQIj5M> is still a prototype. For more information from SNV Vietnam, contact Tuong Duc or Dagmar Zwebe.

4.6.1 Rice Husk Gas Stove Model RHGS 15D (Philippines)

Target area:	Rural villages worldwide where both rice husk is available and there is access to electricity.
Fuel type:	Rice husk.
Designed by:	Prof. Alexis Belonio / Centre for Rice Husk Energy Technology-CPU, Iloilo City, the Philippines.
Retail price:	45-50 USD.
Units sold:	More than 3,000 units sold in the Philippines and abroad since 2006.
Start of production:	First started to develop the model in 2007, now in its 2 nd generation.
Manufactured by:	Belonio Metal Craft.
Contact:	Lucio Larano, jrev_04@yahoo.com
Address:	Purok II, Pavia, Iloilo, the Philippines, phone +63 927 311 3660.
Production capacity:	25 / week.
Short description:	Width 350 mm, length 350 mm, height 800 mm, weight 7.5 kg, Power heat output 1.2 kW.
Features:	Air supply: 16 Watt, 220V computer fan; airflow can be varied by sliding the shutter plate or by using the rheostat switch; plate-type gas burner for better quality flame and increased ease of char disposal.
Handling:	Lighting at the top with a piece of paper or sprinkling of 1 ml of kerosene, start-up time 1 minute; char removal by tipping the stove over.
Char-making ability:	Very good, charred rice husk can be used for Bokashi-type soil fertility amendments.
User feedback:	Affordable; cheap to run; uses waste rice husk as fuel; convenient to use; easy to ignite; no smoke during operation; flame intensity can be controlled; easy to load fuel and discharge char.
Performance data:	8 minutes to boil 1.5l of water; fuel load of 0.95 kg, batch system of about 40 to 60 minutes per load of rice husk fuel. Test results from a smaller version with less power can be found at: http://catalog.cleancookstoves.org/#/test-results/408
For further information see:	http://www.bioenergylists.org/beloniolowcostrhstove http://en.wikipedia.org/wiki/Alexis_Belonio



Photo 4.59
Stove with
burner head

4.6.2 AGNI STAR and AGNI SUN Rice Husk Gas Stoves (India)

Target area:	Rural/ semi-urban/urban population across the globe.	
Fuel type:	Rice husk.	
Designed by:	Prof. Alexis Belonio from the Philippines (innovator) Improved by Mr. Saurabh Sagar Jaiswal.	
Retail price:	95 USD for Agni Star, 110 USD for Agni Sun.	
Units sold:	6,500 Agni Star, 8,500 Agni Sun.	
Start of production:	April 2012.	
Manufactured by:	Navdurga Metal Industries (Bharat) Pioneering in Rice Husk Fuelled Biomass Gasification Stoves.	
Contact:	+91 916 149 2000 saurabhsagar@ndmi.co.in +91 972 159 1000 vibhore@ndmi.co.in +91 916 150 8000 sales@ndmi.co.in	
Address:	Navdurga Metal Industries (Bharat). Head Office: 1 / 8 / 158, Rudra India Hotel, Sagar Building, Fatehganj, Faizabad-224001 Uttar-Pradesh (India). Works: D-33, UPSIDC Site 2 Industrial Area, Mumtaz Nagar ,Faizabad ,Uttar Pradesh(India).	
Production capacity:	3,000 / month.	
Short description:	Agni Star and Agni Sun are second-generation domestic stove technologies with stainless-steel reactors that convert agro-waste, primarily rice husk, into gaseous fuel for domestic cooking without smoke or soot. Agni Star is the smaller version: 1 batch load of 600wg of rice husk can last for 40-45 minutes, enough to cook a meal for 4-6 persons. Agni Sun is the larger version: 1 batch load of 1 kg of rice husk can last for 60-70 minutes, enough to cook a meal for 8-10 persons.	
Features:	1) Available with an AC / DC adaptor and solar 5W solar panel to charge the battery. 2) A 12 V DC fan 0.40 Amp and a 4.5 AH SMF battery configured inside the charge cum fan controller; control of flames via potentiometer. 3) An LED light also configured with the controller that can be used as a torchlight.	
Handling:	Top ignition with few pieces of paper; start time 3-5 seconds; manual char removal by turning stove over.	
Char-making ability:	Excellent, can be used for soil conditioning.	
User feedback:	Low fuel cost; traditional taste of foods retained; easy to ignite; bluish flame like LPG; portable.	
Performance data:	Agni Star: Thermal efficiency: 34%, CO 5.23 g / MJd, PM 80 mg / MJd, 2.16kW firepower. Agni Sun: Thermal efficiency 32%, CO 9.7 g / MJd, PM 61 / MJd, 2.17kW firepower. Tested By IIT-Delhi. 10 minutes to boil 4 l of water (temperature rise from 26° C – 93° C).	
Further information:	More to Agni Star: http://ndmigroup.com/Agni%20Star.html More to Agni Sun: http://ndmigroup.com/Agni%20Sun.html http://stoves.bioenergylists.org/content/nav-durga-metal Approved by MNRE, Government of India, listed member of Nepal Alliance for Clean Cook Stoves: http://www.nepalcookstoves.org/categories.php	

Photos 4.60 + 4.61
Agni Star
(NDMI)

4.6.3 Paul Olivier gasifiers (Vietnam)

Paul Olivier has taken Alexis Belonio's concepts further so that they can now be mass-produced with stainless steel, allowing for crucial parts such as the burner to be made to precision by punch-cutting. Production of the model with a 150 mm diameter reactor started in 2013, with over 100 units produced so far. Field trials are planned for 2014 in Malawi and Senegal.

The new design features are: a small fan within perforated housing that rests on the curved primary air pipe protruding from the reactor. This ensures that the fan can easily be detached and also stays cool; the pipe doubles as a cool-to-the touch handle. Along with the grab-handle above, the two allow for the char to safely be dumped out. While the burner head represents the original design by Belonio, an additional burner housing was added. As an entire housing section or second wall around the reactor would otherwise be costly and entail material durability issues, Paul Olivier recommends building an enclosure for the stove in the kitchen. This adds stability to the tall stove and reduces the risk of burns when the reactor is hot. An enclosure can cheaply be made using bricks and cement or it could be made more sophisticatedly, like the stainless steel unit at a restaurant in DaLat. Read more at:

<https://dl.dropboxusercontent.com/u/22013094/Paper/Summaries/Gasification.pdf>

Paul Olivier is also developing other models with the same burner concept: a larger version for higher power output and a much shorter model for densified rice husk pellets.



Photo 4.62
Clean flame of a
150 gasifier burning
rice husk



Photo 4.63
The 150 gasifier



Photo 4.64
The 150 gasifier in a stainless-steel
enclosure



Photo 4.65
Left to right: The short reactor for
pellets, the 150, and 250 gasifiers

(all photos
P. Olivier)

4.6.4 Thai Binh gasifier – cast-iron top gasifier (Vietnam)

Targeted area:	Thai Binh and other northern delta provinces in Vietnam.	
Fuel type:	Rice husk.	
Designed by:	Mr. Dao Ngoc Viet.	
Retail price:	12 USD (include 2 USD fan with adapter).	
Units sold:	Over 2,000.	
Start of production:	2010.	
Manufactured by:	Ngoc Viet Mechanical Engineering Workshop.	
Contact:	Mr. Dao Ngoc Viet vietngoc.pluswin@gmail.com	
Address:	An Phu 1 village, Quynh Hai commune, Quynh Phu district, Thai Binh province.	
Production capacity:	200 / month.	
Short description:	Robust and cheap single-wall metal-tube reactor (16 cm diameter, 60 cm height), cast-iron burner on top (5 cm pot holder height), welded legs for stability.	
Features:	Forced-air supply via a DC fan with an AC / DC adapter attached to it; fan attached at the bottom of the reactor; natural secondary air supply at the top of the burner; burns with aesthetically pleasing blue-pinkish flame.	
Handling:	Batch-fed on top, top-lit.	
Char-making ability:	15% char and 5% ash; char can be combusted at the end of the gasification process for about 5 minutes.	
User feedback:	Advantages: No smoke, powerful flames, cheap price, robust quality. Disadvantages: Dangerous (very hot body temperature, red colour during gasification process observable on the outer surface), becomes unstable with large pots without an enclosure.	
Performance data:	Full load capacity: 1.6 kg rice husk, can last 45 minutes at low fan speed, 35 at high speed. Burn rate: 35-45 g / min. 2.5 l of water boil in 10 minutes using 474 g of fuel, emitting 20 g CO and 155 mg PM2.5. Emissions during boiling + 30-minute simmer: CO 33.7 g / MJ, 215 mg / MJ PM2.5 (SNV Vietnam testing result).	
Other comments:	Other comments: High fan speed resulted in high CO emissions. The burner should be optimised. The link http://www.youtube.com/watch?v=KdqVIY8EXZM shows the stove in operation. Please note that the other stove that does not ignite (shown at the end) is a copy made by a local tin-smith without adhering to the TLUD principles, so the design has some fundamental flaws and the stove does not function.	

Photo 4.66
(Tuong, SNV Vietnam)

4.6.5 Two-wall stainless steel gasifier (Vietnam)

Targeted area:	Rice-farming rural areas in Vietnam.	
Fuel type:	Rice husk.	
Designed by:	Unknown.	
Retail price:	10-20 USD, depending on material used.	
Units sold:	Estimated over 10,000.	
Start of production:	2009.	
Manufactured by:	Many local workshops in Hanoi, Thai Binh, Quang Binh, Ha Tinh, Hung Yen, and Nam Dinh provinces.	
Contact:	Advisor at SNV Vietnam Mr. Do Duc Tuong. tdo@snvworld.org	
Production capacity:	400 / day; assembly using flatpack parts (at a family-sized workshop in Rua village, in Hanoi).	
Short description:	Built with various material options, some with very thin stainless steel that has a short lifespan.	
Features:	Forced-air supply via a 12 V DC fan with an AC / DC adapter attached to the fan. Fan independent of stove structure and at the bottom of reactor. Double layered. Secondary air supply comes from the space between the reactor and the stove body.	
Handling:	Batch-fed on top, top-lit.	
Char-making ability:	15% char and 5% ash. Char can be combusted at the end of the pyrolysis process for about 3-5 minutes, though this is not recommended as it drastically reduces the lifespan of the stove, sometimes down to below 3 months. The hot temperatures burning the char cause the material to warp and / or melt, especially when the fan is not switched off, creating a forge.	
User feedback:	There have been many complaints about material quality (metal too thin, needs regular steel). Stoves melt after 2-3 months. See: https://www.dropbox.com/s/8vtu2mcfli41qk3/2layer_TLUD_VN_poor_material_quality.jpg Otherwise quite stable, but fan is too powerful. No maintenance or guarantee (door-to-door sales only).	
Performance data:	Full load capacity: 1.4 kg of rice husk. Burn rate: 25 g / min. 1.4 kg rice husk gives maximum burning time of 45 minutes at low fan speed; 35 minutes at normal fan speed. Boils 2.5 l of water in 9 minutes with 432 g of fuel, emitting 5 g of CO and 152 mg PM2.5. Emissions during boiling + 30-minute simmer: CO 3.5 g / MJ, 226 mg / MJ PM (SNV Vietnam testing result).	
Other	The link http://www.youtube.com/watch?v=ozBh26L9zZI shows the stove in use. Many local workshops have tried to reduce costs by using low-quality metal (not stainless steel). This led to quick deterioration of the stoves, causing consumers to lose confidence and causing demand to collapse in early 2013. Thereafter, most producers stopped production. One lesson was that quality assurance is key for sustained demand and a healthy market.	

Photo 4.67
Blue and yellow flames

Photo 4.68
Thin, stainless-steel flatpack parts for assembling the stove (both photos Tuong, SNV Vietnam)

4.6.6 Infrared modified-downdraft gasifier (Vietnam)

Targeted area:	Rural farming areas in Vietnam.	
Fuel type:	Rice husk.	
Designed by:	Unknown.	
Retail price:	120-150USD (depending on the number of burners).	
Units sold:	Estimated 1,000.	
Start of production:	2009.	
Manufactured by:	Thuan Phu Trading Ltd., Co.	
Contact:	Mr. Trong Thuanphu9@gmail.com	
Address:	Cho Nom, Dai Dong commune, Van Lam district, Hung Yen province.	
Production capacity:	300-500 / month.	
Short description:	Modified downdraft gasifier system, combustible gas piped from top to one or two infrared remote burners. Forced-air supply via a 12V DC fan attached to the bottom of the reactor, providing both primary air and secondary air with two separate valves. Single walled. Two imported parts, the infrared burner and fan from China.	
Handling:	Batch-fed on top. A piece of newspaper is used for ignition at the bottom before feeding fuel into the reactor. Fuel should be pressed tightly in the reactor.	
Char-making:	15-20% char. Char is usually not combusted, preventing the reactor from becoming hot.	
User feedback:	Long preparation time and effort; dirty liquid tar; very strong smell; too smoky at start-up; nice flame; suitable for large cooking demand (e.g. rice wine, cakes).	
Performance data:	Full load capacity: 10 kg of rice husk. Burn rate: 17 g / min. Boils 2.5 l of water in 11 minutes with 432 g of fuel, emitting 6g of CO and 35 mg of PM2.5. Emissions during boiling + 30-minute simmer: CO 9.6 g / MJ, 60mg / MJ PM (SNV Vietnam testing result). CO emission and PM2.5 were measured at the burner only. Leakage from reactor was not measured since hood does not cover the entire stove.	
Other comments:	Video showing the operation of the stove: http://www.youtube.com/watch?v=Y6lHAXtO8JM Smoky and quite difficult start-up, 5 minutes to start up.	

Photo 4.69 + 4.70
Downdraft Gasifier
with remote burner
(Tuong, SNV Vietnam)

4.7 Devices focused on biochar production in developed countries

This category is a new addition to this edition, meant for people in developed countries who are interested in biochar-production, who wish to obtain a well-functioning device, and who do not have access to cookstoves from developing countries. This is merely the first attempt – the next edition is expected to have many more devices on offer.

4.7.1 PyroCook by Stephan Gutzwiller (Switzerland)

Target area:	Switzerland, Western Europe	
Fuel type:	Woodchips, pellets from agricultural residues, dry bread, nutshells, cacao shells, dry coffee pulp. Restrictions: Calorific value of feedstock > 12 MJ/kg, maximum moisture content of 35%, size of chunks 5-50 mm, pore volume > 25%.	
Designed by:	Stephan Gutzwiller.	
Retail price:	572 EUR.	
Units sold:	52.	
Start of production:	August 2012.	
Manufactured by:	Zumbrunn AG, Thürnen, CH.	
Contact:	Stephan Gutzwiller, info@kaskad-e.ch	
Address:	Kaskad-E GmbH, Dornacherstr. 192, 4053 Basel, Switzerland www.kaskad-e.ch	
Production capacity:	150 / year.	
Short description:	<p>Process: Top-lit up-draft (TLUD), concurrent flow pyrolysis with upwards natural draft Batch operating: feedstock is filled once.</p> <p>Instrumentation: Primary and secondary air controllers for improved burning, additional secondary air supply via a central pipe, removable chimney and pan tripod.</p> <p>Dimensions: Width 340 mm, length 340 mm, height 760 mm, weight 11 kg.</p> <p>Power: 1.2-2.5 kW in the pan (depending on feedstock) during 0.5-3 hours per batch.</p> <p>Biochar yield: 25% of the dry mass of the feedstock = 200-1,200 g per batch.</p>	
Features:	The pyrolysis gas flame can be used for cooking or as light source with a fire-resistant glass cylinder.	
Handling:	At the end of the process, the flame extinguishes automatically. Then the primary air-flow is cut, the chimney is removed and the char is poured into a pot of water.	
Char-making ability:	Yes.	
User feedback:	Clean; little smoke; very fast ignition.	
Further information:	www.kaskad-e.ch http://www.kaskad-e.ch/Datenblatt_PyroCook_2013.pdf http://www.kaskad-e.ch/A3-Poster_TLUD-Verfahren_PyroFarm.pdf	
Other comments:	Based on the <i>PyroCook</i> ; Kaskad-E started development of a device 10 times larger in 2013, resulting in the <i>PyroFarm</i> , which can feed a central heating system and produce biochar for agriculture soils.	

Photo 4.71
PyroCook 2012
(S. Gutzwiller)

Figure 4.3
Airflow with pre-heated secondary air in the PyroCook

4.8 Further Reading

The Xunda group in China is among the largest producers of gasifier stoves worldwide. This manufacturer of household appliances and cookstoves is little known outside of China. They have a variety of downdraft remote burners and TLUD biomass burners in their section *New Energy*. The SilverFire TLUDs originate from here. Read more at: <http://www.xunda.cc/newEbiz1/EbizPortalFG/portal/html/03.html>

Read about field experience of coupling fuel production with stove dissemination:

- Zambia: Emerging solutions www.emerging.se or www.givecooking.com. Read their story in *Chapter 3*.
- Rwanda: Inyenyeri <http://inyenyeri.org>, with plans to become the largest pellet supplier in East Africa.
- Niger: Aaron stove http://www.proener.unito.it/relazioni/rapport_fourneau_Aaron.pdf
- Senegal: The local rice company, CNT, and GIZ are experimenting with different processing options for Typha grass, rice husk and rice straw, more news in 2014.
- Burkina Faso: German AgroAction adapts gasifiers to local briquette production in cooperation with Joerg Fingas.

Read about field experience concentrating on stove dissemination only:

- Uganda: Mwoto stoves <http://www.mwotostove.com>, report on the BEIA project.
- Costa Rica: Estufa Finca, promoted by SeaChar <http://seachar.org>
- India: Servals Champion Stove in the Sundarbans, read their story in *Chapter 3*.
- Haiti: PREB (Pyrolise réchaud eco briquettes) stoves for biomass briquettes, designed by Pierre Guentert and Stephan Gutzwiller from Switzerland in the context of a project financed by REPIC. Since 2011, 100 units have been produced by D&E Green in Port au Prince with a starting price of 25 USD. Contact: Pierre Guentert, p.guentert@sunrise.ch or go to Madame Maurice Maria Romia, # 02 Rue Métivier, Route de Frères, Pétionville, Haiti. More information about the stove (in German): http://www.kaskad-e.ch/html/ig_pyrolyse.html and a report: http://www.kaskad-e.ch/Pyrolysekocher_REPIC_Schlussbericht_v05_web.pdf

Information on stoves designed for charred fuels and also able to function as TLUDs:

- From Port-au-Prince, Haiti: info@ticadaie.com: Stove based on TLUD principles, designed for charcoal dust briquettes.
- From the USA: The Ecozoom Jet (see *Photo 4.72*) was designed as a charcoal stove (<http://ecozoomstove.com/portfolio-type/zoom-jet>). Due to its unique TLUD-like design, it is able to burn dry goat droppings, a natural granular fuel. Even in the absence of a concentrator disk, pre-heated secondary air can reach the centre of the combustion zone and fill nearly the entire upper area with gasifier-like flames that burn up all smoky gases. It can be used as a dual-fuel stove for raw as well as carbonised biomass.

Beyond cooking

As micro-gasifiers are becoming more widely known and used, people are discovering the advantages of their steady heat output and extended run-times without refuelling, which is important for temperature-sensitive processes. Paul Olivier in Vietnam has some good examples for the productive use of gasifiers in coffee roasting and paint drying in a workshop. See:

<https://dl.dropboxusercontent.com/u/22013094/Paper/Summaries/Gasification.pdf> or
<https://dl.dropboxusercontent.com/u/22013094/Paper/Presentations/Gasification.ppsx>

Photo 4.72

An Ecozoom-Jet charcoal stove burning goat droppings cleanly



5. Biochar

The rising interest in Biochar has put char-producing gasifiers on the international agenda. Probably more projects promoting gasifier stoves were initiated in recent years with the goal to produce biochar for depleted tropical soils than with the aim to protect human health or save fuel to protect forest resources. As an introduction to the topic Kelpie Wilson, previous Communications Editor of the International Biochar Initiative, granted permission to reprint the first chapter of her e-book *Make Your Own Biochar Stove* © www.biochar-ebooks.com, published in 2013:

Photo 5.1
Some seeds that
sprouted in a bucket
of biochar
(K. Wilson)



5.1 What is biochar?

Biochar is charcoal that is made for use in soil. Biochar is made from biomass (like wood or straw) by applying heat in the absence of oxygen. Heat bakes the biomass, releasing flammable gases and leaving behind a solid carbon structure - charcoal. Charcoal is beneficial as a soil amendment. It absorbs and holds water, air and nutrients, making them available to plants. Charcoal works best in soil if it is composted with other organic matter first. Composting makes it more compatible with soil. When we add charcoal to soil it becomes biochar.

The history of biochar

In the Amazon rainforest, people added biochar to soils over thousands of years to help grow food crops in the poor tropical soils. Tropical soils can grow giant rain forests, but when the forest cover is removed, rain washes the soil away. Biochar helped people stabilize the soil for agriculture. A lot of the biochar is still there, thousands of years later. Even today, farmers value these old, black Terra Preta soils for their increased productivity compared to the nearby red soils.

Before the development of modern agricultural technology, farmers in Japan, China, Europe and many other countries, including the United States, used biochar. Farmers wrote about the benefits of charcoal in the first scientific agriculture journals that were published back in the 1800s:

“For two years past I have used some fifty loads each season of refuse charcoal, and being fully convinced that it pays, I wish to recommend it to my brother farmers.”

The New Jersey Farmer, September 1856

The benefits of charcoal in soil were once widely recognized by farmers in cultures all around the world, but access was limited (charcoal is labor-intensive to make) and with the advent of cheap fertilizer made from fossil fuels, the biochar tradition was lost.

Biochar is good for soil

Biochar is like permanent compost - a source of soil carbon that supports soil life, but unlike compost, it does not break down quickly. Compost may last for several years in your soil (and compost is needed as a food source for plants), but biochar will last for decades or centuries. Think of biochar as the *bones* of soil. At a microscopic level, biochar is formed from fused carbon rings that are very stable. This carbon ring structure is like a scaffold that nutrients and minerals hold on to so they stay in the soil where plants can find them.

Biochar is a climate solution

Because plants pull carbon dioxide out of the air when they grow, if you convert part of a plant’s carbon to biochar and put it in the soil, you are reducing the amount of carbon dioxide in the atmosphere. This is called Biochar Carbon Capture. But be careful, your biomass must be sustainably grown and harvested and your biochar production process must be clean, or you might make more carbon dioxide than you bury as biochar.

The process of making biochar releases energy. It is a form of burning or thermal conversion without oxygen that is called pyrolysis. If you can use that energy to substitute for energy from fossil fuels, that is another way that biochar can reduce carbon in the atmosphere. You can use your biochar stove to cook dinner instead of using a gas or electric stove.

Figure 5.1 The carbon cycle versus the biochar cycle

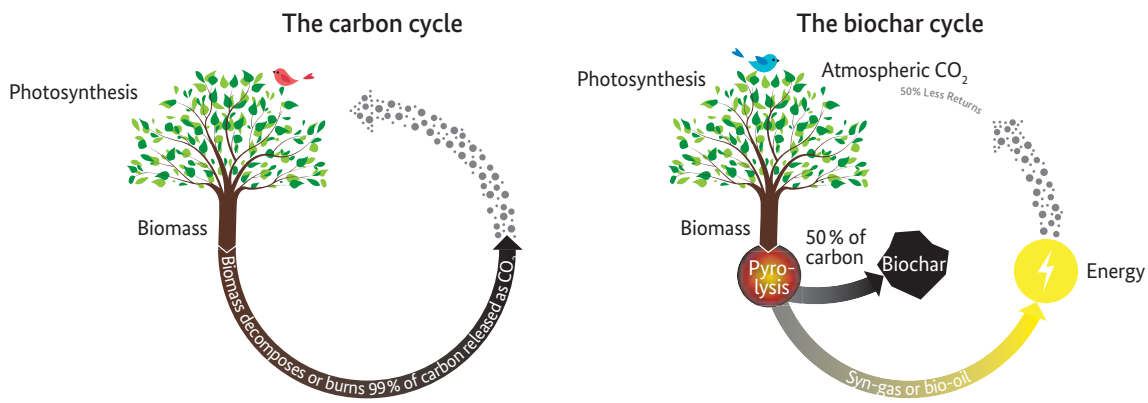

Most carbon returns to atmosphere
 Green plants use solar energy to remove CO₂ from the atmosphere via photosynthesis and store it as chemical energy in biomass. When biomass decomposes or burns, this process is reversed and nearly all CO₂ returned to the atmosphere.

Up to 50% of carbon stays in the soil
 Pyrolysis destroys the structure of the biomass. One half of the carbon is converted to woodgas and the other half remains in the created char. If the char is buried in the soil as biochar, most of the carbon stays there and is sequestered as biochar.

Source: adapted from Wilson (2013), based on Biochar Solutions Inc. (2011)

If we do it right, biochar can help reduce climate change by substituting renewable biomass energy (with biochar carbon capture) for some of the fossil fuel energy we consume. Biochar could be harmful if it is made from unsustainable feedstocks like large trees. Biochar should be made from residues and waste products or quick growing fuel crops that are grown sustainably on formerly degraded land. The goal must be to increase the carbon content of soils and vegetative cover wherever possible. Agricultural practices that deplete carbon in order to grow biofuels would defeat the purpose.

Why make biochar at home?

All over the world, people are starting to make their own biochar for gardens and small farms. It is a cheap and easy solution to many common soil problems: Biochar helps build stable carbon in the soil that supports the soil food web – of the bacteria, fungi and other small animals like earthworms that support plant growth. Biochar also holds water and nutrients in soil, making it a boon to farmers and gardeners who must contend with drought or who struggle to afford fertilizer inputs. The Photo shows one of Kelpie Wilsons experiments using biochar to boost plant growth. This biochar was soaked in urine and composted for several weeks before use.



Photo 5.2
Growth trials by Kelpie Wilson with biochar amendment and pure potting soil

5.2 Using biochar from gasifier stoves in the field

by Thayer Thomlinson (Communications Director, International Biochar Initiative)

Once farmers and landholders have the knowledge and techniques for using biochar in an appropriate manner, the only barrier remaining is the technology to produce charcoal cleanly and efficiently from agricultural waste or other local biomass feedstocks.

The projects below are just a few examples of practitioners developing and disseminating charcoal making cookstoves for the purpose of heating / cooking and using biochar.

One of the largest lessons learned with the implementation of biochar stoves is that it is very important to work at the local level to ensure that the stove model matches available sustainable feedstocks, cooking methods, and finally that the local user understands how to prepare and use biochar in the fields. One of the challenges posed to

rural biochar stove projects can be monitoring and evaluation of not only the stoves themselves, but continued use of the stoves and the effectiveness of the biochar produced as a soil amendment. Some projects are currently undertaking field trials to look at how biochar produced in cookstoves performs in field conditions—and reporting good results.

Kenya: The African Christians Organization Network (ACON) works in Western Kenya to provide opportunities for development that are environmentally sustainable. Since 2004, ACON has been focusing their work on how to reduce deforestation while improving soils for local farmers in the area. Part of this solution is through the use of biochar cookstoves. ACON provides both training to local metal smiths on how to produce biochar cookstoves, but also sells the stoves to local villagers at reduced rates. Additionally, the organization trains farmers and organizations on the use of biochar in fields and assists them in setting up field trials so they are able to see the effects of the biochar amendments on their crops. In 2011, ACON received a grant from National Geographic to expand their work with biochar stove production and outreach, and in 2013, the organization won the Nature Conservancy / RARE *Solution Search* contest East Africa Prize to investigate the use of invasive water hyacinth as a feedstock (in briquette form) for biochar stoves.

Costa Rica: SeaChar, a group initially formed in WA, United States, has been working with indigenous farming communities in the Talamanca region of S.E. Costa Rica to design, test, and disseminate micro-gasification biochar stoves. Their stove model is called the *Estufa Finca* (Farm Stove, described in [Chapter 4](#)). In addition to wood, the stove burns garden debris, dried animal dung, and food material such as dried corncobs and coconut husks. A family cooking a pot of beans will use 40 percent less wood with the *Estufa Finca* than with an open-fire stove. The project is collaborating with CATIE, a research institute in Costa Rica, which is performing rigorous field testing on the biochar produced by the stoves. In 2011, this project received a grant from National Geographic to expand the scope of their work with stoves.

North Viet Nam: A project in working with CARE Viet Nam has been collaborating with rural villagers to continuously improve the performance, usability, and durability of biochar stoves by testing different models and changing design features based on user feedback. In addition to stove design improvements, the project has also developed better sheet metal working machines to help mass produce the stoves at the local level. Villagers working on the project have also received training on how to produce more effective biochar / compost blends and have reported improved results when the blends were used in the fields.

Further reading

- The International Biochar Initiative website at:
<http://www.biochar-international.org/technology/stoves> has more examples of biochar stove projects and examples on biochar use for water filtration and waste water treatment, e.g. by Josh Kearns:
http://www.biochar-international.org/profile/water_filtration
- Read about the potential dual use of biochar for wastewater treatment and soil amelioration e.g. by Marschner et al. (2013):
<http://adsabs.harvard.edu/abs/2013EGUGA..1511260M>
- The site http://www.acfox.com/index_files/Page509.htm has many biochar references, e.g. to the article by McLaughlin (2009). *All Biochars are Not Created Equal, and How to Tell Them Apart*.
- A comprehensive book on *the Biochar revolution- Transforming agriculture* by Paul Taylor can be purchased via:
http://www.amazon.com/The-Biochar-Revolution-Transforming-Agriculture/dp/1921630418/ref=sr_1_1?ie=UTF8&qid=1383668638&sr=8-1&keywords=the+biochar+revolution
- A practical experiment of biochar creation whilst cooking sausages can be found on:
<http://www.biochar.bioenergylists.org/files/2010%20biochar-bq%20demonstration%20by%20Christa%20Roth.pdf>
- A presentation on the roots of biochar and its history by K. Wilson:
<http://greenyourhead.typepad.com/files/the-roots-of-biochar.pdf>

References

- Bonjour, S. et al. (2013): Solid Fuel Use for Household Cooking: Country and Regional Estimates for 1980–2010, *Environmental Health Perspectives*, p 784-790, Volume 121, number 7, July 2013:
<http://ehp.niehs.nih.gov/wp-content/uploads/121/7/ehp.1205987.pdf>
- FAO (2004): Unified Bioenergy Terminology:
<ftp://ftp.fao.org/docrep/fao/007/j4504e/j4504e00.pdf>
- FNR (2007): Handbuch Bioenergie-Kleinanlagen. Fachagentur Nachwachsende Rohstoffe. http://www.tfz.bayern.de/mam/cms08/festbrennstoffe/dateien/handbuch_bioenergie-kleinanlagen-komplett.pdf
- Jetter J. et al. (2012), Zhao Y, Smith KR, Khan B, Yelverton T, Decarlo P, Hays MD: Pollutant Emissions and Energy Efficiency under Controlled Conditions for Household Biomass Cookstoves and Implications for Metrics Useful in Setting International Test Standards. *Environ Sci Technol*. 2012 Oct 2;46(19):10827-34. doi: 10.1021/es301693f. Epub 2012 Sep 17. For non-commercial research and education use, a copy of the article can be accessed at:
<http://ehs.sph.berkeley.edu/krsmith/?p=1387>
- Jetter, J. (2012) Proposed Emissions Tiers for Rating of Cookstoves, presented at the IWA meeting in the The Hague:
<http://pciaonline.org/files/10-Performance-Measures-web.pdf>
- Lask, Kathleen (2013) wrote a thesis on options to ignite a TLUD stove with a lighting cone http://stoves.bioenergylists.org/files/kathleen_lask_masters_report_on_lighting_cones.pdf Find a summary at:
<http://stoves.bioenergylists.org/content/using-metal-cone>
- Means, P. and C. Lannings (2013): The presentation *A simple Alternative to Charcoal*. This presentation illustrates the potential and limits of different processed biomass fuel in comparison to the newly developed crumbles.
<http://www.vrac.iastate.edu/ethos/files/ethos2013/Room%202/Sunday%20PM/A%20Simple%20Alternative%20to%20Charcoal%20.pdf>
- Messinger, C. (2011): The Cooking Energy System:
[https://energypedia.info/wiki/Improved_Cookstoves_\(ICS\)_-_User_Training](https://energypedia.info/wiki/Improved_Cookstoves_(ICS)_-_User_Training)
- Roth, C. (2013): Setting the scene for ‚Emerging Opportunities in Cooking Fuels and Usage‘ at the Bonn International Cooking Energy Forum, June 2013:
https://energypedia.info/wiki/File:Emerging_opportunities_in_cooking_fuels_as_well_as_changing_cooking_habits_-_Christa_Roth_Bonn_2013.pdf
- Smith, K. (2011): *Cooking with Gas*, *Energy for Sustainable Development* 15, p 115-116. Article on usage of fan-assisted gasifier stoves in India. For non-commercial research and education use, a copy of the article can be accessed at:
<http://ehs.sph.berkeley.edu/krsmith/?p=960>
- TFZ (2013): Die Energiedichte biogener Energieträger im Vergleich zu Heizöl und Steinkohle. A German comparison of the energy density of different biomass fuels compared to heating oil and fossil coal http://www.tfz.bayern.de/mam/cms08/festbrennstoffe/dateien/10lsw008_brennstofforgel_.pdf
- WHO (2013): Population using solid fuels (%), 2012:
http://gamapserver.who.int/mapLibrary/Files/Maps/Global_iap_exposure_2012.png

Imprint

Published by

Deutsche Gesellschaft für
Internationale Zusammenarbeit (GIZ) GmbH

Programme

„Poverty-oriented Basic Energy Services (HERA)“

Dag-Hammarskjöld-Weg 1-5

65760 Eschborn

Germany

Tel. +49 (0) 61 96 79 6179

Fax +49 (0) 61 96 79 80 6179

E hera@giz.de

I www.giz.de/hera

Author

Christa Roth with contributions by

Dr Paul Anderson, Dr Hugh McLaughlin, Thayer Thomlinson and Kelpie Wilson

Edited by

Heike Volkmer

Design, Infographics, Illustrations

creative republic, Frankfurt / Germany

Printed by

Metzgerdruck, Obrigheim / Germany

Printed on FSC-certified paper

Photo credits

© Unless another source is stated, all photos were taken by Christa Roth. Other credits go to Awamu Biomass, Banerjee, Bechis, BioLite,

Blucomb, CREEC, Donnelly, ECS, FoST, Gates / Inyenyeri, GIZ / Breiholz, Gutzwiller, Heine, Huangfu, Kayonga, Khoi, Means, Messinger,

Miombo, NDMI, Newdawn, Olivier, Pemberton-Pigott, Prime / Nurhuda, Puffer, Samuchit, SilverFire, TERI, Tobiassen, Troostwijk / African

Clean Energy, Tuong, Vitali, Vwambale, Wendelbo, Wilson

© Shutterstock

As at

February 2014

GIZ is responsible for the content of this publication.

On behalf of

Federal Ministry for Economic Cooperation and Development (BMZ)

Addresses of the BMZ offices

BMZ Bonn

Dahlmannstraße 4

53113 Bonn

Germany

Tel. + 49 (0) 228 99 535 - 0

Fax + 49 (0) 228 99 535 - 3500

BMZ Berlin

Stresemannstraße 94

10963 Berlin

Germany

Tel. +49 (0) 30 18 535 - 0

Fax +49 (0) 30 18 535 - 2501

poststelle@bmz.bund.de

www.bmz.de